

The how-to magazine of electronics...

ELECTRONICTM

Servicing & Technology

OCTOBER 1986/\$2.25

Test equipment for disk drives • What do you know about...cable?

Report from the test lab: the Sencore LC-75

**Seeing
digital operation
with a logic analyzer**

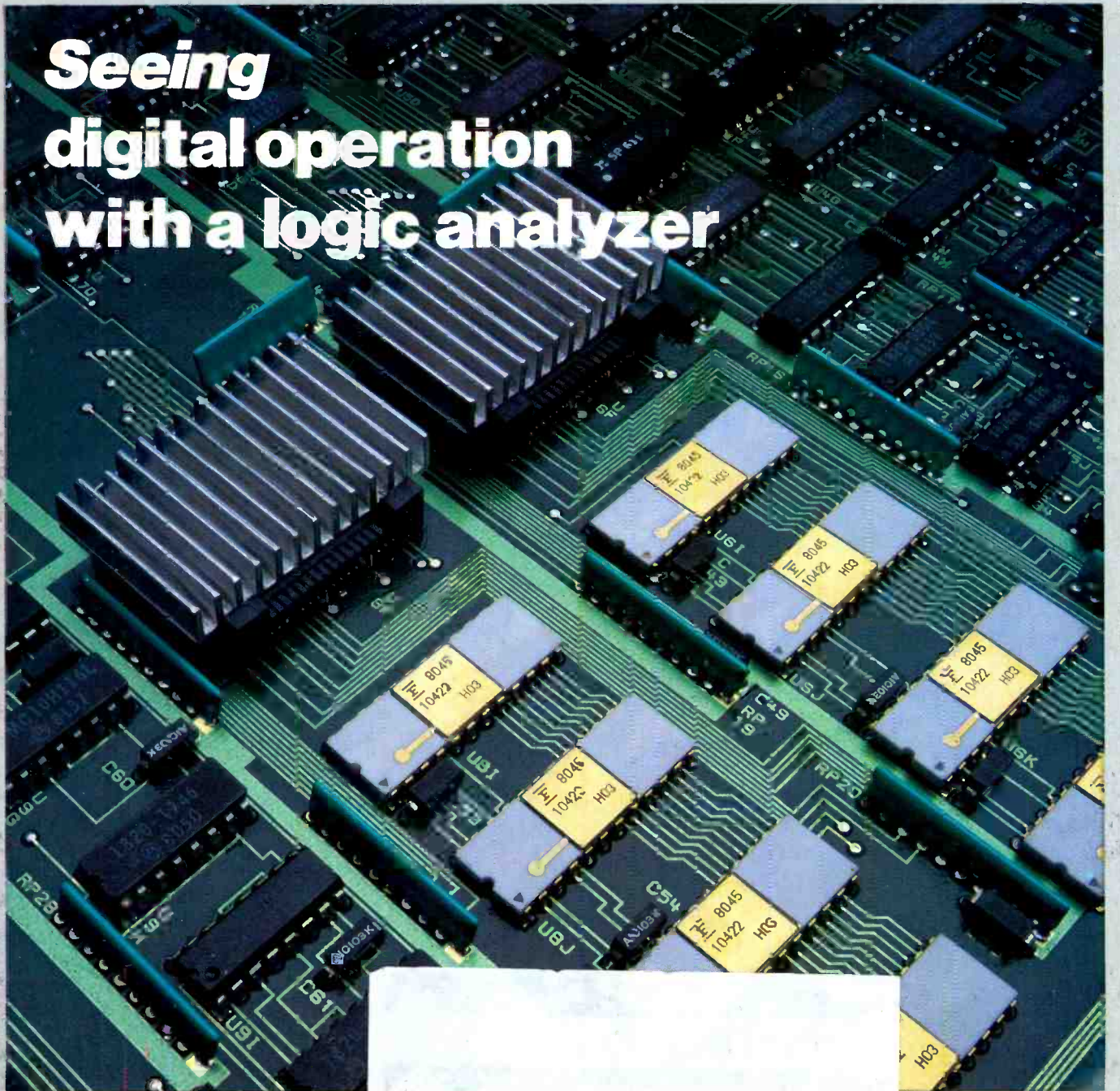

LEADER

LFG-1300S
0.002 Hz-2 MHz



2 MHz

LBO-518
100-MHz Four Channel
Oscilloscope

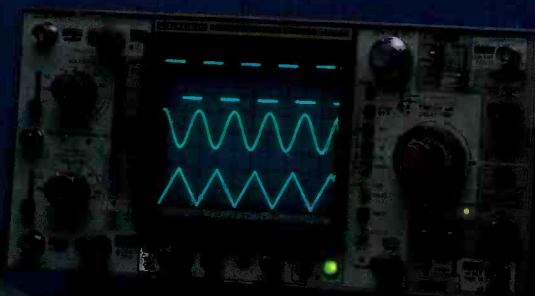

LFG-1310
0.01 Hz-10 MHz



10 MHz

Sweep- Function Generators

Leader 10-MHz and 2-MHz Sweep-Function Generators are exceptionally durable and versatile. They have every important feature, and every required waveform including:

- Sine, square, triangle, sawtooth, ramp, pulse and TTL outputs • 1000:1 and 100:1 ranges
- Adjustable waveform symmetry • AM or FM modulation • VCO and GCV • Linear and log sweep • Plus CW, triggered, gate and burst modes (1310 only) • And lots more!

Call toll-free
(800) 645-5104

In NY State
(516) 231-6900

Request an evaluation unit, our latest Test Instrument Catalog with over 100 outstanding products, the name and address of your nearest "Select" Leader Distributor, or additional information.

For professionals
who
know
the
difference.

LEADER
Instruments Corporation

For Information Circle (1) on Reply Card
For Demonstration Circle (2) on Reply Card

380 Oser Avenue Hauppauge, New York 11788
Regional Offices: Chicago, Dallas, Los Angeles, Boston, Atlanta
In Canada call Omnitronix Ltd. (514) 337-9500

NEW!

OPTIMA ELECTRONICS presents the VIEWSTAR VSC 2500 66-CHANNEL, REMOTE CABLE CONVERTER



VIDEO TUNER WITH VOLUME CONTROL!

- 66-Channel Wireless Remote
- Switches TV on and off
- Remote Volume Control raises and lowers TV audio
- Receives ALL channels offered by your cable company
- Compatible with all brands of decoders
- Decoder Input/Output Jacks
- Remote channel changing
- Last channel recall
- Remote fine tuning
- Special Mute Button instantly silences TV sound — great for answering the phone or 'Killing' commercials
- Optional Audio and Video Outlets for direct hookup to VCR, TV Monitor or Video Transmitter

SPORTS FANS!

One button instant channel switching lets you easily switch n' watch two events.

24-MONTH GUARANTEE

ORDER TODAY — SHIPPED WITHIN 24-HOURS

(On C.O.D. and Credit Card Orders)

ORDERS RECEIVED UP TO DEC. 12 GUARANTEED DELIVERY BEFORE XMAS

\$119⁹⁵

CALL TOLL FREE 1-800-327-0224
FOR MORE INFORMATION
IN FLA. CALL COLLECT 305-920-3550

OPTIMA ELECTRONICS, 2022 Tigertail Blvd., Dania, FL33004

Yes, rush me

___ Cable Converters with volume control @ \$119.95

___ Cable Converters without volume control @ \$89.80

plus \$3.95 per item shipping. (Fla. residents add 5% tax.)

I enclose check M.O. Visa MasterCard for \$ _____ TOTAL

SIGNATURE _____

ACCT. NO. _____ Exp. Date _____

NAME _____

ADDRESS _____

CITY _____ STATE _____ ZIP _____

Circle (38) on Reply Card

OPTIMA ELECTRONICS also carries a fine line of replacement parts for TV, Stereo, VCR, Cable and Telephone Accessories!

14

Report from the test lab: the Sencore LC-75

By Carl H. Babcoke, CET
With this second-generation capacitance/inductance tester, most measurements may be performed by connecting test leads and pushing *one* button.

24

Test your electronic knowledge

By Sam Wilson
You know it's a tough test when the (tough) author admits that 50% is a satisfactory score. This month, subjects covered represent a broad spectrum.

26

Test equipment for disk drives

By Allan Hughes
Two major, specialized testing devices are essential for maintaining disk drives: the simple drive exerciser, and the disk drive tester.

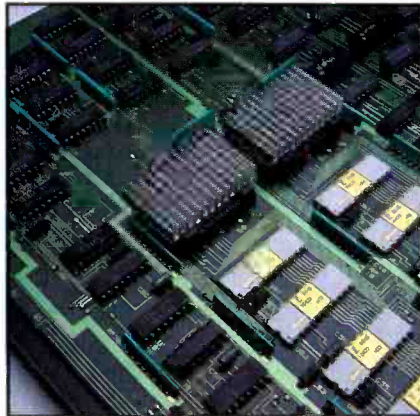

Page 39

To trigger a broad response from several lines, use the digitally specific capabilities of a logic analyzer. (Photo courtesy of Hewlett-Packard.)



Page 10

The intelligent VCR comes home via this time code-equipped, videotape-editing computer designed for consumer oriented video technology. (Photo courtesy of GSE Electronics.)

Departments:

- 6 Editorial
- 8 News
- 9 Feedback
- 10 Technology
- 53 Literature
- 58 Computer Corner
- 60 Products
- 61 Photofact
- 62 Audio Corner
- 64 Reader's Exchange

39

Seeing digital circuit operation with a logic analyzer

Here is a quick course in the basics of logic analyzers. Why, in certain applications, are they more useful than an oscilloscope to a technician?

54

What do you know about electronics? – Cable

By Sam Wilson
In the world of electronics, wire and cable are ever present and, therefore, often taken for granted. This programmed material will refresh your knowledge of coaxial cable as, at the same time, you match wits with Sam Wilson.

58

Computer Corner

By Conrad Persson
A new, monthly feature begins in this issue, confirming suspicions that computers are here to stay!

How to beat the high cost of cheap meters.



You get what you pay for.

So get the Fluke 70 Series.

You'll get more meter for your money, whether you choose the affordable 73, the feature-packed 75 or the deluxe 77.

All of them will give you years of performance, long after cheaper meters have pegged their fishhook needles for the last time.

That's because they're built to last, inside and out. So they're tough to break. They don't blow fuses all the time. You don't even have to replace batteries as often.

And they're backed by a 3-year warranty. Not the usual 1-year.

Of course, you may only care that the world-champion 70 Series combines digital and analog displays with more automatic features, greater accuracy and easier operation than any other meters in their class.

You may not care that they have a lower overall cost of ownership than all the other "bargain" meters out there.

But just in case, now you know.

For a free brochure or your nearest distributor, call toll-free **1-800-227-3800**, ext. 229.

FROM THE WORLD LEADER IN DIGITAL MULTIMETERS.



FLUKE 73

\$79*
Analog/digital display
Volts, ohms, 10A, diode test
Autorange
0.7% basic dc accuracy
2000+ hour battery life
3-year warranty



FLUKE 75

\$99*
Analog/digital display
Volts, ohms, 10A, mA, diode test
Audible continuity
Autorange/range hold
0.5% basic dc accuracy
2000+ hour battery life
3-year warranty



FLUKE 77

\$139*
Analog/digital display
Volts, ohms, 10A, mA, diode test
Audible continuity
"Touch Hold" function
Autorange/range hold
0.3% basic dc accuracy
2000+ hour battery life
3-year warranty
Multipurpose holster

* Suggested U.S. list price, effective November 1, 1985

** Patent pending.



Circle (4) on Reply Card

IN THE U.S. AND NON-EUROPEAN COUNTRIES: John Fluke Mfg. Co., Inc., P.O. Box C9090, M/S 250C, Everett, WA 98206, Sales (206) 356-5400, Other (206) 347-6100.
EUROPEAN HEADQUARTERS: Fluke (Holland) B.V., P.O. Box 2269, 5600 CG Eindhoven, The Netherlands, (040) 456045, TLX 51846.
© Copyright 1985 John Fluke Mfg. Co., Inc. All rights reserved. Ad No. 4714-70

Thanks for your comments

(Here's what we're doing about them.)

During the past year or so we have asked you to provide us with your comments on what you think about the content of *ES&T* when you send in your *ES&T* Readers' Service cards. More recently, we began to ask you to tell us what kinds of articles you would like to see in future issues of *Electronic Servicing & Technology*. And for the past few months we have been asking you to fill out the reader information cards bound into your issue so we could learn more about you: the type of work you do, the type of facility you work in and other such information.

You have been kind enough to take the time to write in your comments and tell us what you like and what you don't like, and what you want to read in future issues. And you have filled out those reader information cards by the hundreds.

Thank you.

The reason behind wanting to learn more about you and your information wants and needs was that we want to be sure that we're publishing just the types of articles that are of the most value to all of our readers.

If you'll take a look at this issue, and the last few issues, you'll see that we have been reading and heeding those cards, and that the information you have been providing is causing us to tailor the editorial content of *ES&T* to match more closely what readers tell us they want.

For example, starting in June, we began a regular audio servicing column written by Kirk Vistain in response to those of you who have told us that we've been neglecting audio. In this column, we've been bringing you details and hints and tips about audio theory and servicing hints that we just wouldn't have been able to cover any other way.

This issue contains another new column that will be appearing monthly: "Computer Corner." Computers have become a fact of life: People are using personal computers in their homes and business in increasing numbers. Dedicated computers are being incorporated into more and more audio and video products and other consumer products. Whether you like them or not, if you plan to continue servicing consumer electronic products, you will inevitably encounter computers. You'll have to learn what they're all

about. This column is designed to help you.

Besides these important additions of article content, we have added more technical expertise to our staffing. The six editorial consultants who have agreed to sit on our editorial board represent a reservoir of knowledge and skills that will help us to ensure that our editorial content is timely and accurate.

And we've reinstated our "Feedback" department: letters to the editor where readers can express their views, positive or negative, about the magazine or any of a number of related subjects. One additional benefit is that it gives readers a place to add to, or suggest, corrections to information that has been published in previous issues of *ES&T*, and so it serves as a place for readers to exchange ideas and information and thus help each other.

Your requests for more information on servicing of VCRs have not gone unheeded, either. We are currently planning to start a new monthly VCR servicing column, similar to "Audio Corner," in January of 1987, bringing you VCR servicing information not just once in a while, but every month.

Some of you have expressed dissatisfaction with the selection of schematics in "Profax." It will not be an immediate change, but we are working with several TV manufacturers, and are hopeful that soon we will be able to improve this valuable feature.

Last but not least, have you taken a close look at the graphics in recent issues? We're striving to improve the look as well as the content of the magazine so that it is easier to read and looks more attractive.

Please note, though, in spite of all of these changes, one thing hasn't changed: We still continue to cover exclusively the technical aspects of all of these subjects. That's what we've always assumed you wanted, and now that's what you've told us unequivocally that you *do* want. That's what we're going to give you.

And by the way, keep sending in those letters and filling in those cards. We want to make this *your* magazine, responding to your information needs.

Nils Conrad Persson

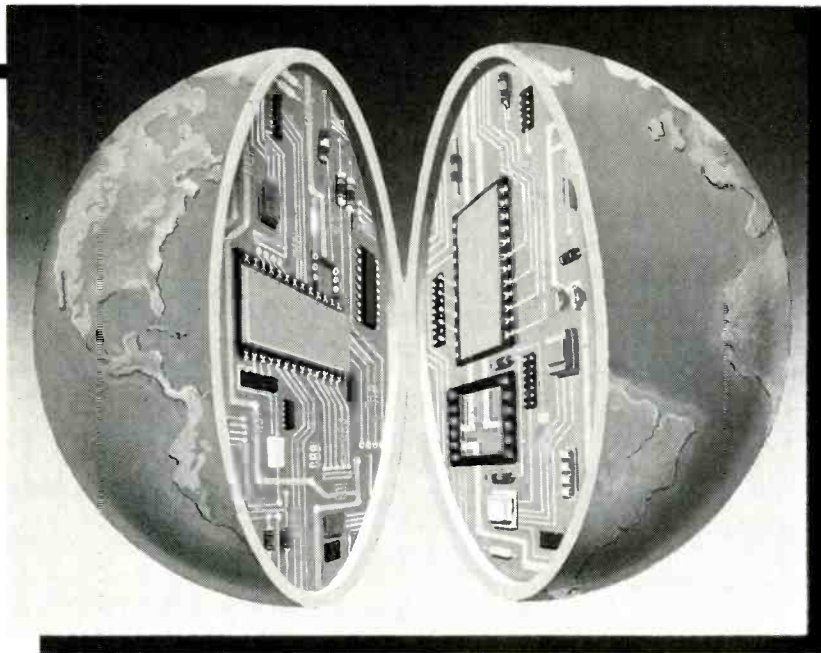

can even earn your Associate in Applied Science Degree in Electronics Engineering Technology. Of course, you set your own pace, and, if you ever have questions or problems, our instructors are only a toll-free phone call away.

The first step is yours.

To find out more, mail in the coupon below. Or, if you prefer, call toll-free 1-800-321-2155 (in Ohio, 1-800-523-9109). We'll send you a copy of CIE's school catalog and a complete package of enrollment information. For your convenience, we'll try to have a representative contact you to answer your questions.

CIE MAKES THE WORLD OF ELECTRONICS YOURS.

Today's world is the world of electronics. But to be a part of it, you need the right kind of training, the kind you get from CIE, the kind that can take you to a fast growing career in business, medicine, science, government, aerospace, communications, and more.

Specialized training.

You learn best from a specialist, and that's CIE. We're the leader in teaching electronics through independent study, we teach only electronics and we've been doing it for over 50 years. You can put that experience to work for you just like more than 25,000 CIE students are currently doing all around the world.

Practical training.

You learn best with practical training, so CIE's Auto-Programmed® lessons are designed to take you step-by-step, principle-by-principle. You also get valuable hands-on experience at every stage with sophisticated electronics tools CIE-designed for teaching. Our

4K RAM Microprocessor Training Laboratory, for example, trains you to work with a broad range of computers in a way that working with a single, stock computer simply can't.

Personalized training.

You learn best with flexible training, so we let you choose from a broad range of courses. You start with what you know, a little or a lot, and you go wherever you want, as far as you want. With CIE, you

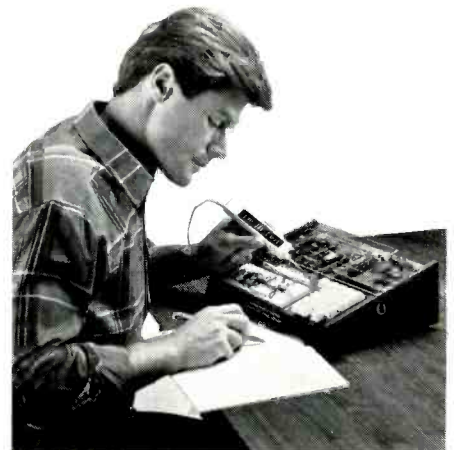

ES-15

CIE Cleveland Institute of Electronics

1776 East 17th St., Cleveland, Ohio 44114

YES! I want to get started. Send me my CIE school catalog including details about the Associate Degree Program. I am most interested in:

- | | |
|--|---|
| <input type="checkbox"/> computer repair | <input type="checkbox"/> television/high fidelity service |
| <input type="checkbox"/> telecommunications | <input type="checkbox"/> medical electronics |
| <input type="checkbox"/> robotics/automation | <input type="checkbox"/> broadcast engineering |
| <input type="checkbox"/> other _____ | |

Print Name _____

Address _____ Apt. _____

City _____ State _____ Zip _____

Age _____ Area Code/Phone No. _____

Check box for G.I. Bulletin on Educational Benefits

- Veteran Active Duty

MAIL TODAY!

OR CALL TOLL FREE 1-800-321-2155 (In Ohio, 1-800-523-9109)

Circle (5) on Reply Card

Samsung expands product support

Samsung Electronics America has instituted a series of VCR training seminars at key locations across the country. According to Bill Clemis, national service manager, this program, which ran in August and September, is the first in a series on Samsung products for technicians.

Organized by Engineering Manager Yong Sup Lee and Product Engineer Ray Klebs, the day-long seminars were held in 23 cities around the country. The seminars concentrated on Samsung VCR repair theory and trouble shooting. More than 800 participants signed up for this company's servicing instruction updates.

Future training programs are planned for Samsung televisions and microwave ovens. Authorized service stations interested in participating in these programs should contact: Product Engineer Raymond Klebs, Engineering Department, Samsung Electronics America, 301 Mayhill St., Saddle Brook, NJ 07662.

VCR service data sweepstakes

Howard W. Sams & Company, a division of Macmillan, has recently announced a nationwide sweepstakes for technical personnel involved in the VCR service repair industry.

The sweepstakes was initiated to inform the service and repair industry about "VCRfacts," technical service data for VCRs, and to gather brand- and model-specific information for equipment that those in the service industry need.

Six valuable test instruments will be awarded in a random drawing on Nov. 3, 1986, at Howard W. Sams & Company headquarters in Indianapolis. The prizes, donated by individual manufacturers include:

Grand Prize: *Sencore*-Universal NTSC video analyzer, model VA62

2nd prizes: *B&K Precision*-NTSC signal generator, model 1251

Simpson-digital multimeter, model 464 D-3

Fluke-digital multimeter, model 8060A

Tegam-digital multimeter, model 130A

Triplet-digital multimeter, model 3360.

Service and repair professionals may enter by calling toll-free, 1-800-428-SAMS, or by writing to Howard W. Sams & Co., VCRfacts, 4300 W. 62nd St., In-

dianapolis, IN 46268, specifying the VCR brand and model for which they would like Sams to provide documentation. Entries must be received by Nov. 1, 1986.

New interface interim standard

The Electronic Industries Association announces the availability of Interim Standard No. 15, "Standard Baseband (Audio/Video) Interface Between NTSC Television Receiving Devices and Peripheral Devices."

Television manufacturers have responded to the cable-TV market by offering models that tune both broadcast and cable-only channels. One (or more) cable channels may be scrambled or encrypted to support a marketing plan such as tiering or premium extra-pay channels. The scrambled or encrypted channels may be viewed by a subscriber through the use of a converter/decoder normally provided by a cable system operator.

The decoder interface, when used with a cable system, will permit the cable operator to reduce the cost of equipment that is normally provided to the subscriber.

Copies of the interim standard may be obtained from the Electronic Industries Association, Standards Sales Office, 2001 Eye St., NW, Washington, DC 20006, at \$12 per copy.

ELECTRONIC

Service & Technology

Editorial, advertising and circulation correspondence should be addressed to: P.O. Box 12901, Overland Park, KS 66212-9981 (a suburb of Kansas City, MO); (913) 888-4664.

EDITORIAL

Nils Conrad Persson, *Editor*
 Carl Babcoke, *Consumer Servicing Consultant*
 Dan Torchia, *Group Managing Editor*
 Marjorie Riggan, *Associate Editor*
 Joy Culver, *Editorial Assistant*
 Darryll Fortune, *Editorial Assistant*
 Alisa Carter, *Editorial Assistant*

CONSULTING EDITORS

Homer L. Davidson, *TV Servicing Consultant*
 Christopher H. Fenton, *Circuit Design Consultant*
 Bud Izen, *Computer Servicing Consultant*
 Victor Meeldijk, *Components Consultant*
 Kirk G. Vistain, *Audio Consultant*
 Sam Wilson, *Electronics Theory Consultant*

ART

Kevin Callahan, *Art Director*
 Tim Lynch, *Graphic Designer*

BUSINESS

Cameron Bishop, *Group Vice President*
 Eric Jacobson, *Publisher*
 Greg Garrison, *Sales Manager*
 Stephanie Fagan, *Promotions Manager*
 Kelly Hawthorne, *Marketing Assistant*
 Dee Unger, *Advertising Supervisor*
 Julie Chilson, *Advertising Coordinator*

Regional advertising sales offices are listed in classified pages.

ADMINISTRATION

R. J. Hancock, *President*
 John C. Arnst, *Circulation Director*
 Jo Ann DeSmet, *Circulation Manager*
 Dee Manies, *Reader Correspondent*



Member, Audit Bureau of Circulation



Member, American Business Press



Member, Electronic Servicing Dealers Association

ELECTRONIC SERVICING & TECHNOLOGY (USPS 462-050) (with which is combined *Electronic Technician/Dealer*) is published monthly by Intertec Publishing Corp., 9221 Quivira Road, P.O. Box 12901, Overland Park, KS 66212-9981. Second Class Postage paid at Shawnee Mission, KS 66201. Send Form 3579 to P.O. Box 12952, Overland Park, KS 66212-9981.

ELECTRONIC SERVICING & TECHNOLOGY is the "how-to" magazine of electronics. It is edited for electronic professionals and enthusiasts who are interested in buying, building, installing and repairing consumer electronic equipment. This includes audio and video equipment, microcomputers and electronic games.

SUBSCRIPTION PRICES: one year \$18, two years \$30, three years \$38 in the USA and its possessions. Foreign countries: one year \$22, two years \$34, three years \$44. Single copy price \$2.25; back copies \$3.00. Adjustment necessitated by subscription termination to single copy rate. Allow 6 to 8 weeks delivery for change of address. Allow 6 to 8 weeks for new subscriptions.

PHOTOCOPY RIGHTS: Permission to photocopy for internal or personal use is granted by Intertec Publishing Corp. for libraries and others registered with Copyright Clearance Center (CCC), provided the base fee of \$2 per copy of article is paid directly to CCC, 21 Congress St., Salem, MA 01970. Special requests should be addressed to Eric Jacobson, publisher. ISSN 0278-9922 \$2.00 + 0.00

INTERTEC
 PUBLISHING CORPORATION

©1986 All rights reserved.

Feedback

Address correction: apologies!

How do you like this for a deal? We won't mention that your reply to a letter in your July "Feedback" column located us in the wrong city, if you will list the five titles Homer Davidson currently has in print with TAB:

"Beginner's Guide to TV Repair-3rd Edition"

"The Illustrated Home Electronics Fix-It Book"

"Pocket Digital Multimeter Techniques"

"Practical Microwave Oven Repair"

"33 Photovoltaic Projects"

Seriously, we appreciate the mention, but take us out of the Springs and up to the Ridge.

W. G. Worsinger

Director of marketing services

TAB Books, Inc.

Blue Ridge Summit, PA

Letter to Sam Wilson

In reference to your article, "Capacitors and Triggers" in *Electronic Servicing & Technology*, you asked for information about gamma. Here is a copy of several pages from a book I read sometime ago.

Jim McTernan

Roselle Park, NJ

I appreciate the material you sent on transistor gamma (from "Transistor Circuit Action," by Henry C. Veatch, c. 1968, McGraw-Hill). Technicians around the country have been sending similar material and I have become more convinced with each letter that the parameter is useless. Without exception, every reference has been an older text. Yours, for example, is from a 1968 book.

I know that the alpha and beta parameters are legitimate. However, because the transistor is a 3-terminal device some authors decided the third (gamma) was necessary to complete the package. I have never seen a case where the gamma of a transistor was really needed.

Thanks for writing. Your letters are very important to us.

Sam Wilson
Electronic Servicing &
Technology

Timely Troubleshooting Tip

I came by a copy of a page out of your magazine, and would like you to send me an order form for a subscription to the monthly issues. I was reading Troubleshooting Tips, March 1985, "Intermittent operation-General Electric AB/AC (Photofact 1904-)" about the reliability of the griplets in these sets. It really helped me in fixing a set that I have. I would also like to add regarding W29A and W29B: Connect A to B if there is a color control that doesn't work. No big deal, but it helped me.

I've only been working on sets for a couple of years now, but think I would enjoy reading your articles.

Wm. C. Herbert
Alexandria, LA

Thank you, Mr. Herbert.

Do you have a comment, a gripe, or some valuable information that you'd like to share with the editors and/or readers of *ES&T*. Please address your comments to *ES&T*, care of the "Feedback" department. If they're of general enough interest and we have the room, your comments might be published here in the "Feedback" column.

ES&T

Correction:

On the lower left hand side of page 28 of the July 1986 issue of *ES&T* there was a B&W photo of a cable test unit. The device and the supplier of the device were misidentified. The caption should have read: "A cable test unit gives you access to cable connection points, and even allows you to disconnect one or more conductors for testing." The device shown in the photo is manufactured by AP Products, who provided the photo.

Capacitance, logic and more. For less.

Now, a fully-loaded DMM combines a capacitance meter, logic probe, and an hFE meter, all for the price of a DMM.

TTL Logic Probe: 20 MHz

Hi/lo/off indications

Detects 25nS pulse width

Capacitance: 5 ranges (2nF to 20 μ F)

hFE (NPN or PNP): 1 range (1000)

DMM: DCV-5 ranges (.2V to 1kV)

ACV-5 ranges (.2V to 750V)

DCA-4 ranges (200 μ A to 10A)

ACA-3 ranges (20mA to 10A)

Ohms-7 ranges (200 Ohms to 2000 Megohms)

Continuity beeper

Diode check

Built-in bail

Anti-skid pads

See one now at your local Beckman Industrial distributor.

DM25L... \$89⁹⁵*



*Suggested list price (\$US) with battery, test leads and manual.

Beckman Industrial™

Beckman Industrial Corporation
A Subsidiary of Emerson Electric Company
630 Puente Street, Brea, CA 92621
(714) 671-4800

© Copyright 1985 Beckman Industrial Corporation

Circle (6) on Reply Card

The first application of RAPID will be in the GSE-manufactured TC-2002 video computer system.

Coming: high-IQ VCRs

A newly developed technology, called *single-frame retrieval and access program in digital* (RAPID), creates a new standard of digital encoding and decoding on normal 1/2-inch tape of a time code, thus introducing a new generation of intelligence to the VCR industry. This development by GSE Electronic Systems allows for rapid access and/or retrieval of any piece of information on that tape, with just the touch of a button. More importantly, the time code has no effect on the quality of the sound or picture.

"The introduction of RAPID represents the single most important advance in consumer-oriented video technology in the last decade," says George E. Huehne, GSE Electronic Systems' president and chief executive officer. "This technology presents the long-awaited next step in the development of a new generation of *smart* VCRs."

Time coding of videotape has been available in costly and professional broadcast quality VCR equipment; the new RAPID technology makes the process applicable to owners of consumer-oriented VCR systems. The implications of this technological advancement will be felt throughout all sectors of the industry, according to Peter Roggendorf, inventor and chief scientist of GSE.

"In its most basic application, the time-coding of videotape can be compared to a table of contents in a book: It provides rapid access and retrieval of information contained in that medium," Roggendorf says. "On a more complex level, this system opens the door to an endless variety of creative edit-



GSE Electronic Systems' TC-2000 opens the door to the complete range of interactive video editing capabilities.

Circle (135) on Reply Card

ing functions previously unavailable to the home hobbyist, as well as the broadbase commercial, industrial and institutional user."

The RAPID system is designed to access or locate the specific position of a single-frame on a videotape. This is done through decoding or reading a time code that was encoded or written into the synchronization track of the tape during or after recording.

The RAPID time code is generated as a pulse-phase-code, a type of code that allows the control impulse to carry additional bits of information, without influencing the actual purpose of the synchronization impulse (CTL-impulse).

The code generated by the RAPID system is not recorded within a wide bandwidth on the

INTRODUCING THE REPLACEMENT FOR OUR REPLACEMENT GUIDE.

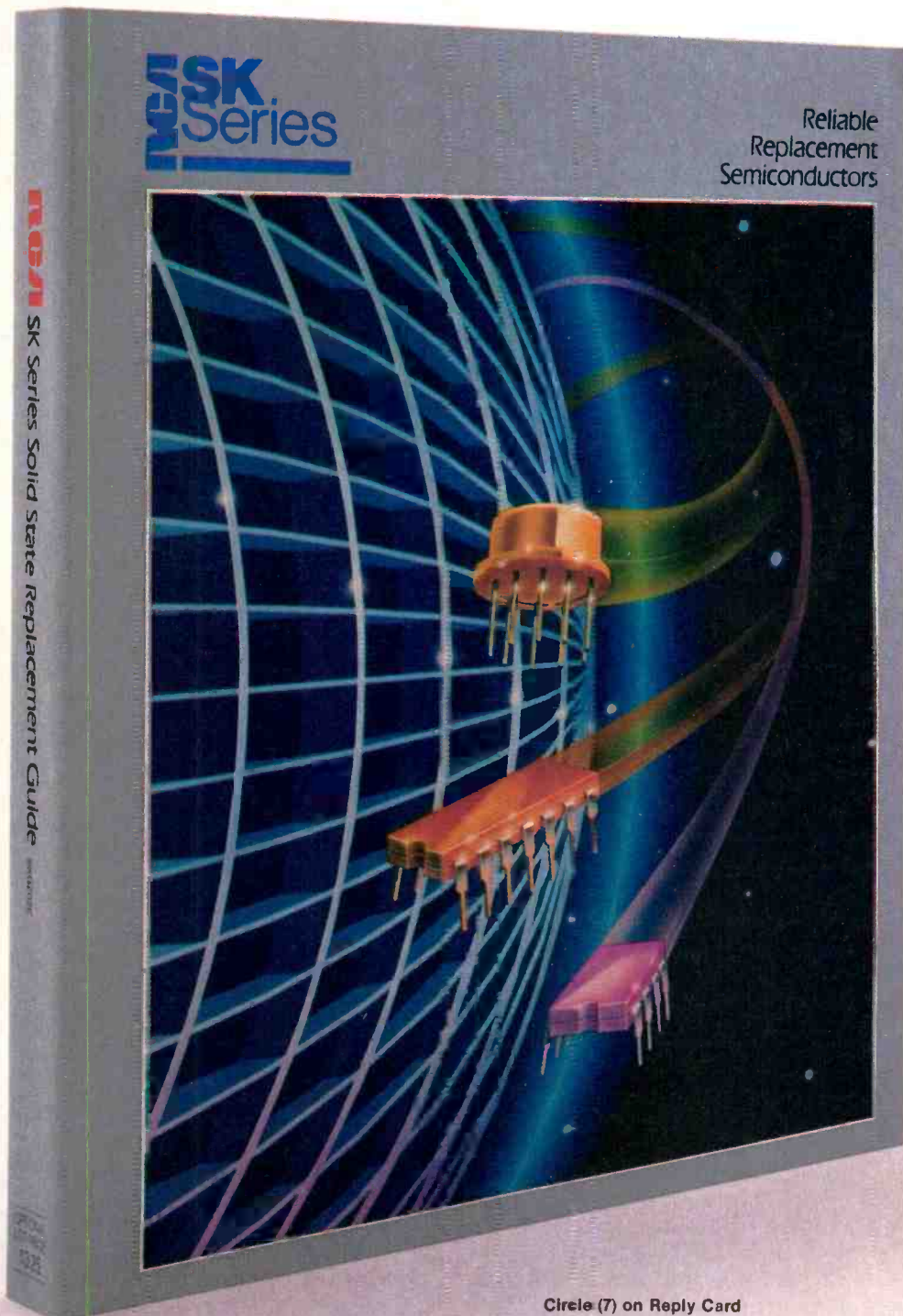

RCA's new SK Guide gives you fast, accurate solid state replacements.

In the world of semiconductor replacements, no one outperforms RCA's engineering excellence. We're in the business of manufacturing semiconductors, so you can depend on our reliability.

Our new, expanded RCA SK Guide to Reliable Replacement Semiconductors lists more than 2,900 SK and KH types that replace over 214,000 industry types. And, for the first time, QMOS logic devices and an extensive line of RF types are included.

The new RCA SK Replacement Guide (SKG202E). It's the only solid state replacement source you need. For a copy, see your RCA SK Distributor. Or mail a check or money order for \$3.25 to RCA Distributor and Special Products Division, Box 597, Woodbury, New Jersey 08096-2088.

RCA SK Replacement
Solid State

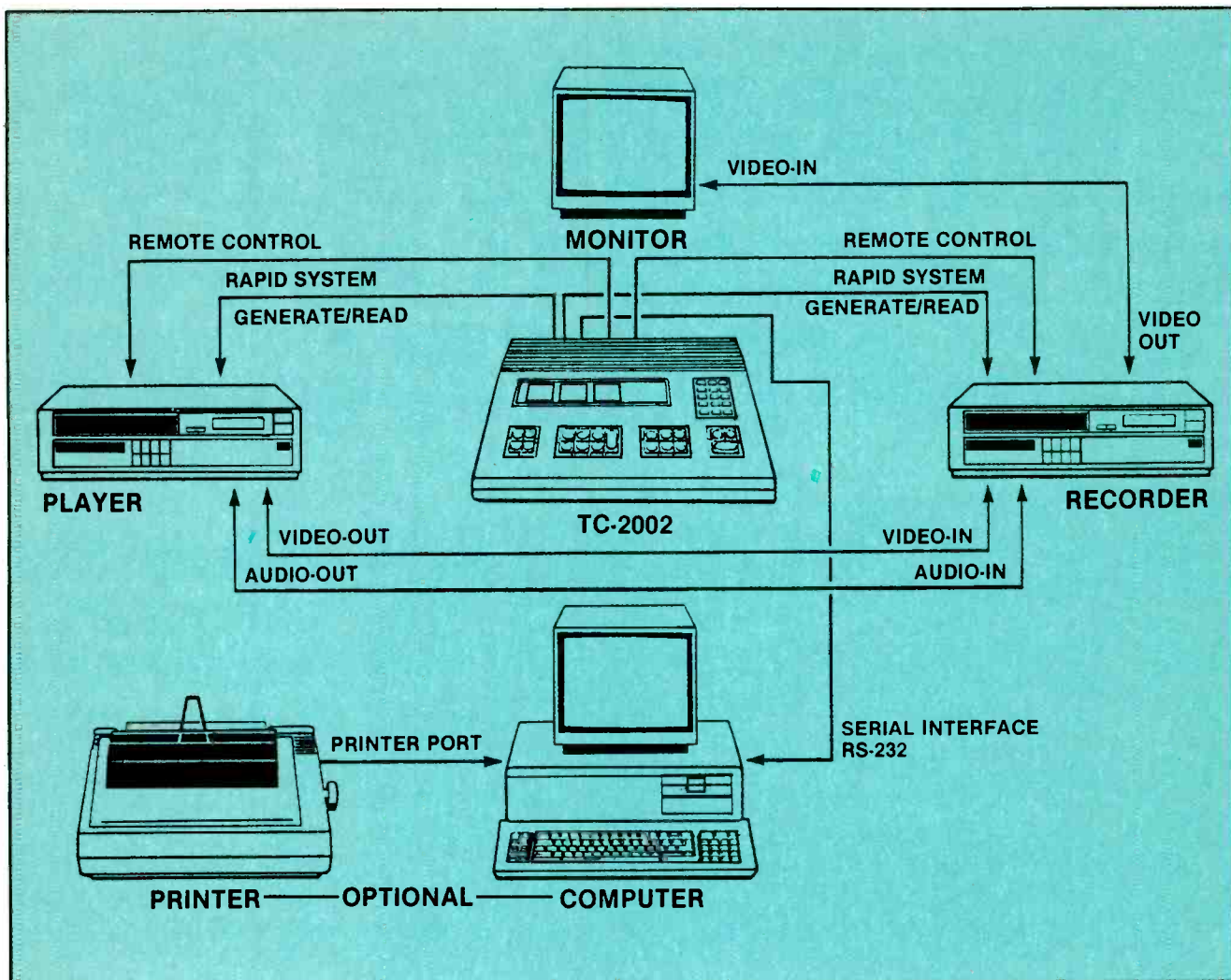

audio track (compared with the SMPTE/EBU time code standard). Rather, the code is placed very narrowly on the synchronizing track. This track, which records the CTL-impulse, is used for synchronizing the revolutions of the head drum in the VCR. It is the usage of the CTL-track by the RAPID System's narrow-bandwidth pulse-phase-code that allows, for the first time, the use of a time code by a normal VCR.

The time code will be transmitted in blocks of 50 bits, each containing all information necessary for determining its exact location on the tape itself: hour, minutes, seconds frame speed—25 per second or 30 per second. Additional information also may be encoded such as tape number or user code.

"The code also has a *checksum*, a control word that checks for any errors that may occur during the reading of a videotape." Roggen-dorf says. "This system of checking and rechecking guarantees error-free results.

"Even *dropouts* on the tape no longer create any problems, again thanks to the continuous checking by the code itself. Every single frame you want to record is put in its place after the valid identification of the code, thereby ensuring the position of the frame to within plus/minus one frame."

GSE has identified a wide range of applications for the technology throughout all sectors of the video industry. The firm already has begun a diverse product development and technology licensing program to introduce the system to the home video electronic market. With a golf-instruction tape coded with the system, for example, the user would be able, with the touch of a button, to move to specific points on the tape for individual points of instruction.

The first application of the technology will be in a GSE-manufactured video computer system, the TC-2002, that will make available a complete editing system to a full range of users.

GSE

AWS TEST INSTRUMENTS



DML-4020 DATA LOGGING DMM

This microprocessor controlled portable instrument contains two autoranging digital multimeters, four comparators, one timer and a 2 inch dotmatrix printer. Both DMM's may be used individually or simultaneously to measure and record all functions. The dot matrix printer provides numerical or graphic printouts displaying sampled values at pre-selected automatic or manual time intervals. The recordings end with a calculation of lowest/highest values, number of sample intervals and calculated average. Comparator output signals are available for actuating external equipment. \$1,000.00.



DM-6592 ELECTRO-PROBE™ DMM

One of the smallest, most convenient hand-held DMM's you'll ever own. It's both autoranging and manual and is the perfect instrument for taking readings easily and accurately in hard to reach areas. Other features include instant audible continuity buzzer; one-hand operation; electronic overload protection on all ranges; data-hold button. Ranges: 0-200m/2/20/200/500Vdc; 0-2/20/200/500Vac; 0-200/2K/20K/200K/2000K/20MΩ. \$65.00.

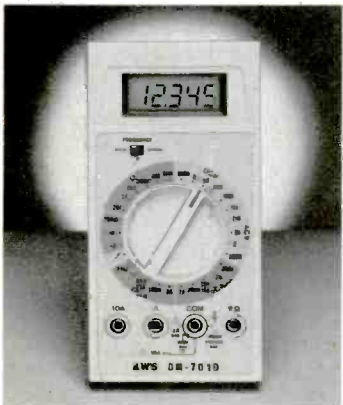

DM-7010 4½ DIGIT ROTARY SWITCH DMM

High accuracy readings in the laboratory or in the field. Features include 4½ digit 19999 max. display, built-in frequency counter to 200KHz and conductance function; 0.05% basic dc volts accuracy; overload protection on all ranges; special electronic protection to 250Vac/dc on resistance ranges; UL1244 type test leads; diode and continuity tests; Ranges: 0-200m/2/20/200/1000Vdc; 0-200m/2/20/200/750Vac; 0-200μ/2m/20m/200m/2/10Aac/dc; 0-200/2K/20K/200K/2M/20MΩ; 0-200nS conductance; 0-20K/200KHz frequency. \$170.00.



DM-1 POCKET-PRO™ DMM

Big features are packed in this pocket-calculator sized DMM. You'll find autoranging; electronic overload protection on all ranges; auto-polarity; audible and visual continuity indication; built-in test leads; "booklet-type" carrying case is designed to fit easily in shirt pocket. Ranges: 0-2000m/20/200/400Vac/dc; 0-200/2000/20K/200K/2000KΩ; 0-200Ω continuity. \$29.95.



BL-4 CLASSMATE DIGITAL BREADBOARD LAB

Nicknamed "The Instructor's Best Friend", this completely self-contained classroom lab combines a breadboard, DC power supply (fixed and variable), signal generator (sine, triangle and square wave outputs), digital voltmeter, 8-bit LED display, BCD to 7 segment decoder and display, flip-flop gate and logic switches in one compact unit. The BL-4 is only 11" x 13" leaving more work station area free for other instructional materials and requires only one electrical outlet. \$349.95.

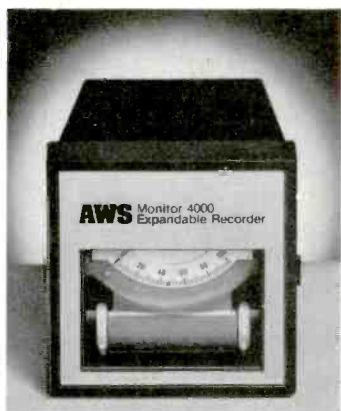

MONITOR 4000 EXPANDABLE RECORDING SYSTEM

The new recording system that can be expanded on as needed. Start with the XR-4000 basic 3 speed recorder, add any of five volt/amp or temperature modules, then select any of five transducers for easy current or temperature measurements. The XR-4000 can be panel mounted, used on a bench top or as a portable in its functionally designed carrying case. Basic XR-4000 3 speed recorder \$229.95. Complete kits start at \$399.95 and include XR-4000, module, transducer, carrying case, chart paper, tilt stand.

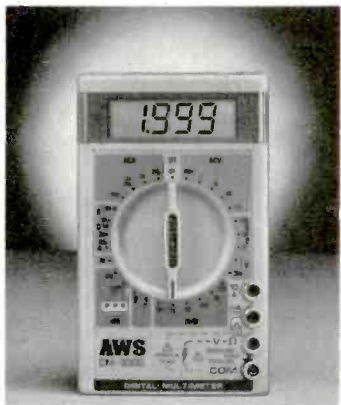

DM-3000 3½ DIGIT ROTARY SWITCH DMM

Just one of three DMM's in our Economy Series that combines quality with economy. Features include built-in HFE, battery and diode testing; conductance function; 300 hour battery life; 10Adc range; electronic overload protection on all resistance ranges; pocket-sized. (Also available models DM-1000 & 2000). Ranges: 0-200m/2/20/200/1000Vdc; 0-200m/2/20/200/750Vac; 0-200μ/2m/20m/200m/10Aac/dc; 0-200/2K/20K/200K/2M/20MΩ; 1.5V battery test; 0-1000 Hfe test; 2KΩ diode test. DM-1000: \$39.95 / DM-2000: \$54.95 / DM-3000: \$69.95.

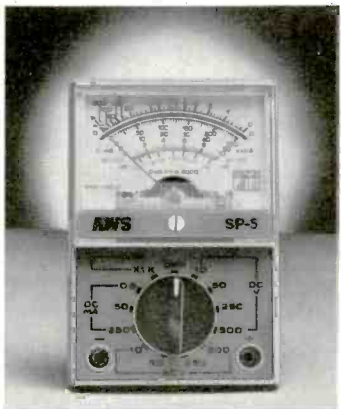

SP-5 POCKET-SIZE MULTIMETER

An unbelievable \$9.95 buys you this small yet surprisingly rugged multimeter. Perfect for the professional, homeowner and hobbyist. Its big features include safety recessed test lead connections; high impact ABS plastic case; mirrored scale plate; diode protected meter movement; uses only one 1.5V AA battery. Ranges: 0-10/50/250/500Vac/dc; 0-0.5/50/250mAdc; 0-1MΩ (5KΩ mid-scale); -20 to +56db. \$9.95.

A.W. SPERRY INSTRUMENTS INC.

For more information see your local distributor or contact A.W. Sperry Instruments Inc.
245 Marcus Blvd., Hauppauge, N.Y. 11788 • 800-645-5398 Toll-Free (N.Y. and Alaska call collect 516-231-7050).

Circle (8) on Reply Card

Reports from the test lab:

The Sencore LC-75

By Carl Babcoke

Sencore model LC-75 *Z Meter II* is a second-generation capacitance/inductance tester with many features, including auto-ranging. Most measurements with the LC-75 can be performed by attaching the test leads to the component and pressing one button for each test. When a capacitor is measured, for example, one button is pushed and the capacitance value appears on the LED readout. Pushing another button provides a digital-accuracy readout of the capacitor's leakage.

A test for the *equivalent series-resistance* (ESR) of capacitors has been incorporated into this instrument. ESR will be explained in detail later. One button has been added for the ESR test, which is so simple it requires little instruction. Dielectric absorption also can be tested, but no extra circuits or push-buttons are needed. Accurate, dependable measurements of ESR and dielectric absorption are vital for technicians, and we congratulate Sencore for providing solutions to these problems.

Two separate measurements are possible for inductances. The inductor *value* button measures and displays the inductance in μH or mH of almost any coil that is connected to the test leads. Also, deflection yokes and flybacks (but not transformers with laminated cores) can be tested for shorted turns in the windings by use of the *ringer* button (plus the ringer impedance-matching knob). Ringing duration and amplitude varies with the relative "Q" of the inductance. Lab tests and work ex-



The Sencore LC-75 *Z Meter II* provides a complete analysis of inductors and capacitors. Inductances are tested directly in μH and mH , in addition to an improved version of the time-proven ringer test. Capacitors are checked for capacitance, leakage, dielectric absorption and ESR. All functions except ringing are autoranged.

perience both agree that ringer readings are more affected by shorted turns within a winding than are the inductor-value readings, although the inductor-value readings are reduced, too.

Testing capacitors

During each capacitance test with the LC-75, the capacitor is charged through a precision resistor, and the time required for the capacitor voltage to reach +5V is measured precisely, but the time is calibrated in pF or μF . The precision resistor and the capacitor undergoing the test together make up an RC time-

constant circuit. A small capacitance charges to +5V quickly, but a large capacitance charges more slowly, giving a larger readout.

Ten auto-selected ranges measure from 1pF to $199,900\mu\text{F}$. Accuracy is rated at $\pm 1\%$ of reading plus a resolution error of $\pm 1\text{pF}$. For capacitances larger than $1,000\mu\text{F}$, the accuracy is $\pm 5\%$ of reading plus the resolution error.

Measuring a capacitor is very easy. Attach the two meter leads (observe polarity only with electrolytics) to the capacitor, remove your hand and press the *capacitors value* push-button. Usually, by the

time you look from your push-button finger up to the LED readout, the capacitance is displayed with the correct decimal point. Also, another LED at the right is glowing to show whether the reading is in pF or μF . That is all, except for the leakage test, which should be done next.

Very-large-capacitance electrolytics require slightly more time to produce a reading, but the LC-75 gives a reading fairly quickly. For example, the LC-53 (the original Z meter, which remains available) requires eight seconds to measure a $100,000\mu\text{F}$ electrolytic, but the LC-75 needs only four seconds, thanks to some new circuitry.

For best accuracy of capacitances below $1,000\text{pF}$, the test leads should be placed where they will not be moved very much when they are connected to the capacitor. Without anything connected to the test leads, press the value button and slowly adjust the *lead-zero* control for a 00.0 readout, with the negative sign appearing sometimes. Without moving the leads very much, connect the capacitor to the test leads and measure the capacitance by pressing the *value* push-button.

Capacitances of less than 2pF sometimes read 00.0 because of the auto-ranging window. To measure them, disconnect the capacitor, slowly offset the *lead-zero* control until 2pF is shown. Then connect the capacitor, measure it, subtract 2pF from the readout and the remainder is the capacitance. Don't forget to reset the readout to 00.0 after the measurement, or ESR and inductance measurements will not be accurate. Do not rest the test leads on a metal surface or near a strong acV field; errors of measurement can result from these mistakes.

Capacitor-leakage tests

This LC tester has a simple but excellent leakage test sequence for capacitors. Dc voltages for capacitor-leakage tests are selected by the 12-position *leakage-voltage* switch that gives a choice of +3V, +6V, +10V, +15V, +25V, +50V, +100V, +200V, +300V, +400V, +500V and +600V. Next, the *leakage-range* switch selects either of two leakage-current ranges, and this current will be displayed accurately on the LED readout when the

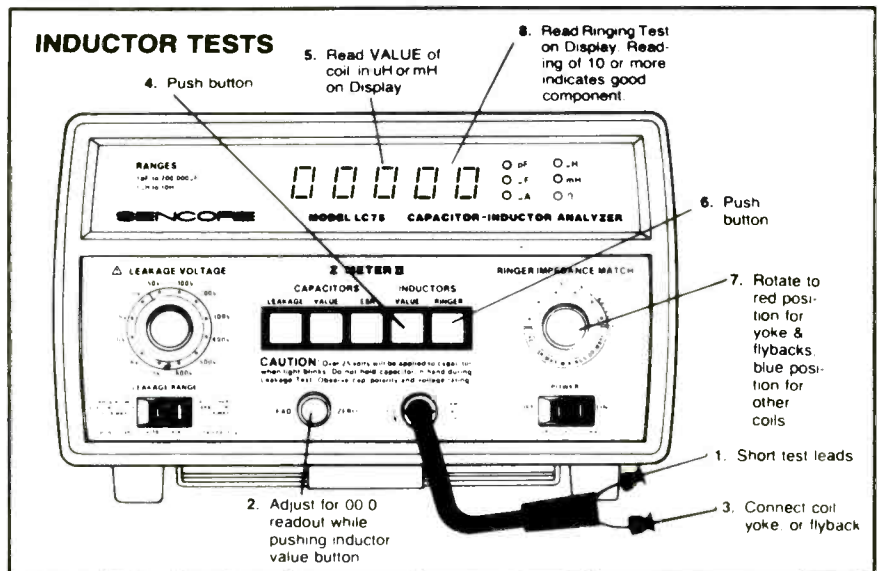

Twelve pages of charts, precise testing connections and other helpful data are available conveniently from the *pull-out* under the machine. One picture shows the pull-out fully extended, and the other is a close-up of one test setup.

leakage pushbutton is pressed.

An LED at the right of the *leakage-voltage* switch blinks about two or three times per second when the switch is adjusted for any leakage voltage from +50V to +600V. That part of the dial has a red background as another warning that dangerous voltages are present at the test leads during these leakage tests. Be sure to observe those warnings of the shock hazard.

For larger aluminum electrolytic

capacitors, press the left side of the *leakage-range* rocker switch for leakages up to $10,000\mu\text{A}$. Press the right side of the rocker switch to select the $100\mu\text{A}$ maximum rating for all other types of capacitors, such as small electrolytics, mica, film, ceramic, polycarbonate, polyester, or paper dielectric types. Any of these that have leakage current (following an appropriate charging current) should be considered defective.

Most electrolytics show some

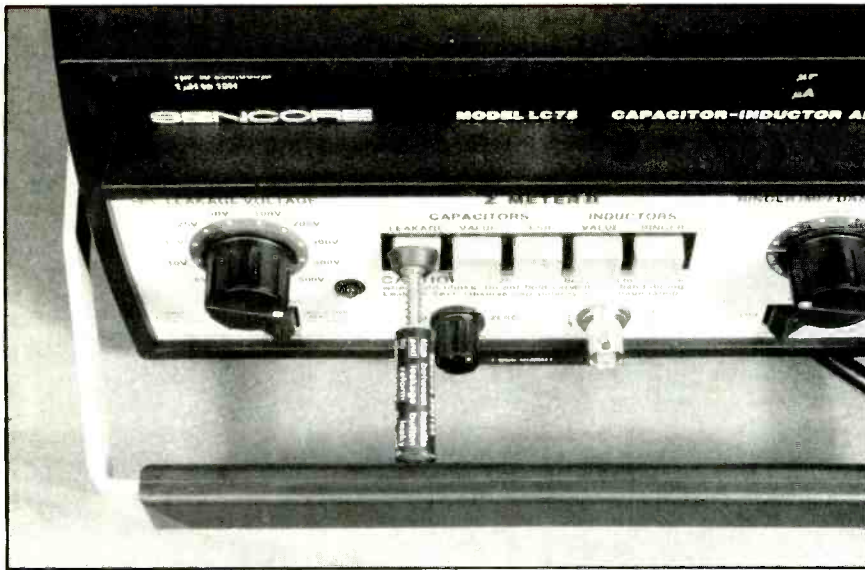

Application of rated dc voltage to a capacitor sometimes is needed to reform the electrolytic material. In fact, sometimes the voltage must be applied for several minutes to bring down the leakage so it can be tested correctly for capacitance. A 39G154 hold-down rod is included with the LC-75. Move the tilt stand around in front and place the rod between it and the leakage button. There are dangers, so take precautions, as explained in the operation manual.



If capacitor leakage is excessive, the overrange sign (three flashing 8's and one constant 8) will show on the read-out when the *capacitor-value* button is pressed. This capacitor was formed and the leakage decreased, thus allowing a normal capacitance read-out.

leakage, ranging from slight leakage to a near-short. The LC-75 operation manual has charts of allowable leakage vs. voltage and capacitance. Another set of charts is included with the *pull chart* under the LC-75.

Some leaky electrolytics can be reformed by operating them with rated dc voltage while the current is monitored to see if it decreases. The process might require considerable time, perhaps an hour in stubborn cases. To keep the leakage button pressed, a 39G154 *test-button hold-down rod* is included with the LC-75. Pull the com-

bination handle/tilting-brace out in front of the machine in line with the leakage push-button and place the hold-down rod between the button and the handle so the push-button is held in. **Do not do this with any other buttons**, and do not operate any other push-buttons while the leakage button is depressed. Leakage in excess of 10mA causes the highest leakage range to be exceeded, activating the overload signal (three 8's flashing *on* and *off*). A capacitor with this much constant leakage should be considered defective.

A 500 μ F 100Vdc tubular

capacitor that had been in stock for about two years was tested. The capacity tested 572 μ F but at first the leakage was excessive, with the readout showing the 888 overrange symbol. With the leakage button steadily pressed by the hold-down rod, the leakage within three minutes had decreased into the measurement area and showed a slow downward trend. After about 15 minutes of forming at +100V, the leakage became only 10 μ A, with the reading erratically dropping to 000. At the same time a digital multimeter measured 98V across the capacitor, and a scope at full gain showed only small sawteeth from integrating the dc pulses.

When the Sencore LC-75 tests pronounced the capacitor to be normal, the DMM and scope tests verified the good performance.

I found one capacitor that could not be formed, but the problem was not with the tester. In a box of miscellaneous capacitors was an old 8 μ F 450V tubular electrolytic filter capacitor. The capacitance was high, around 15 μ F, but the problem was leakage. On the high current position of the *leakage-range* switch, the leakage activated the flashing 8's, *but not at the rated 450V*. The highest voltage that could be applied and have the current finally drop into the measurement range was 15Vdc. Yes, 15Vdc not 450V. The forming test started when the leakage dropped to approximately 9,000 μ A (accurate figures are not needed now), and finally reached 3,810 μ A with some variations. Then the reading went down to about 3,700 μ A and up to almost 3,900 μ A. Curiosity extended the test. Therefore, I will label the capacitor with all its defects and place it in a box with others that are valuable only for trying capacitor testers.

LC-tester vs. ohmmeters

Compared to ohmmeter readings, the leakage readings from the Sencore LC-75 are incomparably better on all counts. The 8 μ F 450V rating capacitor (discussed earlier that had excessive leakage current above 15Vdc) measured 100k Ω on a good sensitive VOM with reversed polarity and 1M Ω with correct polarity. No indication there of

Now electronics technicians can get into VCR Servicing quickly and easily

Learn professional VCR servicing at home or in your shop with exclusive videotaped demonstrations

Today, there are more than 10 million VCRs in use, with people standing in line to have them serviced. You can bring this profitable business into your shop with NRI professional training in VCR servicing. This top-level training supports the industry's claim that the best technicians today are those who service VCRs.

Integrated Three-Way Self-Teaching Program

In one integrated program, NRI gives you a study guide, 9 instructional units, 2 hours of video training tapes accompanied by a 32-page workbook that pulls it all together. At home or in your shop, you'll cover all the basic concepts of video recording, mechanical and electronic systems analyses, and the latest troubleshooting techniques. Your workbook and instructional units also contain an abundance of diagrams, data, and supplementary material that makes them valuable additions to your servicing library.

The "How-To" Videotape

Your NRI Action Videocassette uses every modern communications technique to make learning fast and easy. You'll enjoy expert lectures and see animation and video graphics that make every point crystal-clear. You'll follow the camera eye into the heart of the VCR as step-by-step servicing techniques are shown. Both electronic and mechanical troubleshooting are covered . . . including everything from complete replacement and adjustment of the recording heads to diagnosing micro-processor control faults.

Plus Training On All The New Video Systems

Although your course concentrates on VCRs covering Beta, VHS, and 3/4" U-Matic commercial VCRs, NRI also brings you up to speed in other key areas. You'll get training in capacitance and optical video disc players, projection TV, and video cameras. All are included to make you the complete video technician. There's even an optional final examination for NRI's VCR Professional Certificate.



Covers Beta *and* VHS
systems with actual
instruction on
videotape.

The Best Professional Training

This exclusive self-study course has been developed by the professionals at NRI. NRI has trained more television technicians than any other electronics school! In fact, NRI has consistently led the way in developing troubleshooting techniques for servicing virtually every piece of home entertainment equipment as it appears in the marketplace.

Satisfaction Guaranteed . . . 15-Day No-Risk Examination

Send today for the new NRI Self-Study Course in VCR Servicing for

Professionals. Examine it for 15 full days, look over the lessons, sample the videotape. If you're not fully satisfied that this is the kind of training you and your people need to get into the profitable VCR servicing business, return it for a prompt and full refund, including postage. Act now, and start adding new business to your business.

Special Introductory Offer

This complete VCR training course with two hour videotape is being offered for a limited time only, on orders received from this ad, at our low introductory price of \$179.95. Save \$20 by acting now!

NRI Training For Professionals
McGraw-Hill Continuing Education Center
3939 Wisconsin Avenue Washington, DC 20016

YES! Get me started in profitable VCR servicing. Rush me my NRI self-study course in VCR Servicing for Professionals. I understand I may return it for a full refund within 15 days if not completely satisfied.

PLEASE SPECIFY TAPE FORMAT DESIRED VHS BETA

Name (please print) _____

Company _____

Street _____

City/State/Zip _____

Enclosed is my check money order for \$179.95 (D.C. residents add 6% tax) Make check payable to NRI

Charge to VISA MasterCard _____
Interbank Number _____

Card Number _____ Expiration Date _____

Signature _____

(required for credit card sales)



NRI Training For Professionals
McGraw-Hill Continuing
Education Center
3939 Wisconsin Avenue
Washington, DC 20016

2630-106



This capacitor-leakage test showed low leakage, but at a low 6V. If the capacitor voltage rating is between the LC-75 voltages, use the next lowest.

low-voltage leakage, although the VOM had 8.3V across its probes. The digital multimeter ohmmeter was less help. Usually an over-range on all ranges except for those few times that unstable (and obviously incorrect) readings could be obtained.

Out of the dozens of electrolytics I measured were two marked identically, 330 μ F at 16V. One had excessive leakage that a 10-minute forming time would not help enough, while the other had good low leakage. These two were compared by VOM and DMM ohmmeter readings. Although the low-leakage capacitor had higher resistances, both with normal polarity and reversed polarity, the differences were slight and not sufficient to be the base for any law or even a handy tip.

In comparison with the Sencore LC-75 leakage tests, the resistance tests of voltohmmeter and digital multimeter are almost useless. Only in rare cases where the capacitor has a dead short can the VOMs and DMMs identify it as defective. The previous comment about resistance tests of capacitors being almost useless was not made on the basis of two measurements, but several dozen electrolytics were measured on LC-75, DMM and VOM. Only the LC-75 leakage tests were valid and accurate.

Testing dielectric absorption

Simply stated, dielectric absorption is the failure of a capacitor to discharge completely

to 0V, even with a dead short across it. Evidently the dielectric retains some charge. Electrolytic-type capacitors are more likely to have DA, although other types occasionally acquire DA. The test for DA is easy, just follow this sequence:

- Connect the capacitor to the LC-75 test leads and test the capacity value. Notice the reading, preferably writing it down for accuracy.
- Test the capacitor at its rated working voltage. Keep the *leakage* button pushed in until the leakage current drops to the maximum allowable reading (shown on the leakage chart).
- Release the *leakage* button and wait for the display to reach 000, then immediately press the *value* button and notice the capacitance reading. Write it down also.

If the capacitance reading is only 5% or less below the original reading, and the reading drifts slowly upward toward the original value (or if both readings are the same) the capacitor has very little DA and is good.

A change of value between 5% and 15% indicates the capacitor might need reforming. Recheck the dielectric absorption after the capacitor has been reformed.

If the second value reading differs by more than 15% from the first reading, and the reading after the leakage

test changes upward rapidly toward the first value, the capacitor has excessive DA. Some electrolytics can have the dielectric absorption reduced by reforming. If the DA is unchanged after reforming, the capacitor is defective and should be replaced (it's likely to cause problems in the circuit).

Note: All mica or film-dielectric capacitors that show *any* dielectric absorption should be considered defective and they should be replaced.

Testing ESR

Sencore LC-75 has one more push-button than its predecessor, the LC-53. This push-button is labeled *ESR* for *equivalent series resistance*. A filter capacitor can have the correct capacitance but cause serious problems because of ESR, see page 19.

Testing ESR with the LC-75 is extremely easy. Assuming that the capacitance *lead zero* control has been correctly set for capacitance *value* measurement, the next step after capacitor *leakage* measurement is pressing the ESR button alone. The ESR in ohms appears on the LED readout.

Two charts of maximum allowable ESR (for standard aluminum electrolytic and for solid tantalum) according to capacitance and operating dc voltage are included in the LC-75 operating manual. They also are included with the pull-charts that are stored below the LC-75 cabinet for easy access.

If the ESR exceeds the maximum allowable figure, the capacitor should be replaced.

The LC-75 ESR readings can extend from 0.10 Ω to 999 Ω in three automatically selected ranges. Accuracy is rated at $\pm 5\%$ of reading plus the resolution error, which is quite adequate for ESR readings. Capacitances smaller than 1.0 μ F cannot be tested with accuracy. However, a 0.5 μ F electrolytic type with a high ESR probably would give a high reading, regardless of accuracy.

When measuring low amounts of ESR, short together the two test leads, and zero the test-lead resistance by rotating the *lead-*

zero control until the readout shows 0.00 with the minus sign appearing sometimes. Then after the ESR test or tests are finished, recheck the lead-zero for capacitance value, and adjust as needed.

Effects and symptoms of ESR

A perfect capacitor would have an ESR of 0Ω , but real-world capacitors have ESRs that vary. Also, the ESR of a capacitor can increase with time, especially when it is stored and not used. This explains why some electronic products operate the same (or even worse) after a certain capacitor has been replaced with a new one. Leakage and ESR of the replacement might have been worse than those of the original capacitor.

Problems with ESRs become more apparent if you study the effects of various resistances connected in series with a perfect capacitor. One application is shown in Figure 1. The ESR resistance prevents the capacitor from eliminating the very high frequencies from the signal. Assum-

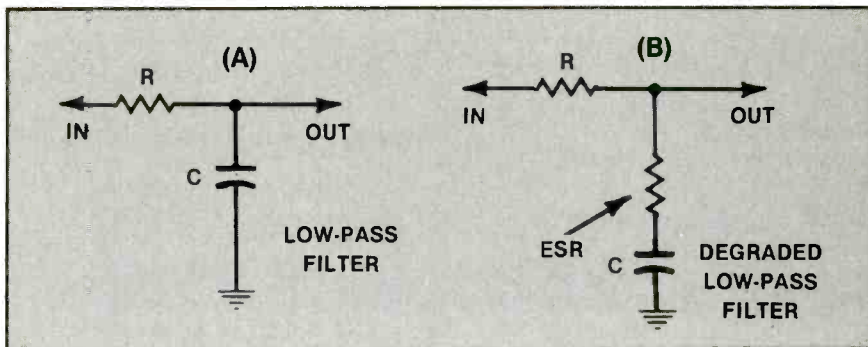

Figure 1. Excessive ESR in a bypass or filter capacitor acts as the second resistor marked ESR in schematic B. With schematic A, above a certain frequency the frequency response goes down at 6dB per octave to almost zero. However, with the ESR resistor (schematic B) the frequency response goes down for a time then levels off, with no further HF decrease. The key is in the ratio of the equivalent series resistance of the capacitor vs. the resistance of resistor R. In schematic A, the ESR is assumed to be zero, while in schematic B it is larger, in the order of 1/10 to 1/20 of resistor R. Assume that R is $9k\Omega$ and ESR is $1,000\Omega$. The initial downward slope of the frequency-response curve is not affected much by the ESR's addition. But consider a very high frequency where the reactance of the capacitor C is near zero; then the circuit becomes a 9-to-1 voltage divider, with 10% of the input appearing at the output.

ing a complex waveform with many harmonics (pulses or square waves) or related frequencies (video), if the ESR resistance is 1/9th of the series resistor Figure 1B signals of 1/10 of the value of the input signal will appear at the output at frequencies that should be removed by the filter. In Figure

1A, the output is 00%.

That residue of high-frequency hash at the capacitor does not appear to be a problem until you consider that it might be small amounts of video that the high ESR allows to enter the AGC signal. Or it might be sections of horizontal pulses at the cathode of

TEST INSTRUMENTS Lowest Prices Off-The-Shelf Directly To You

HITACHI 35 MHz DUAL TRACE OSCILLOSCOPE

Model V-355

\$599⁹⁵

(Reg. \$899.95)
Probes included.

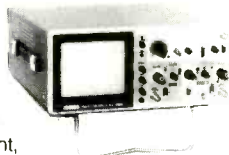

- Thin, lightweight, compact • Large 6" rectangular, internal graticule CRT
- Autofocus

FREE!

**LOGIC PROBE
BP LP189
(\$40.00 VALUE)**
with purchase of
Model V-355

FORDHAM 550 MHz FREQUENCY COUNTER

Model FM-8

\$169⁹⁵

(Reg. \$249.95)



Completely assembled, pre-tested, pre-calibrated • High intensity 8-digit LED display

☎ ☎ ☎ Phone orders accepted.

B&K 60 MHz TRIPLE TRACE OSCILLOSCOPE

Model 1560

\$899⁹⁵

(Reg. \$1150)
Probes included.



- 1 mV/div sensitivity
- 22 calibrated
- sweeps • Rectangular CRT
- w/internal graticule & scale illumination • Autofocus

FLUKE 3½ DIGIT MULTIMETERS & VOLTMETERS

Model 73 **\$74⁹⁵**

Model 75 **\$89⁹⁵**

Model 77-F **\$119⁹⁵**



FORDHAM SWEEP FUNCTION GENERATOR

Model FG-801

\$199⁹⁵

(Reg. \$289.95)
Test Leads included.



SPECIAL PRICE!

- 7 frequency ranges, 0.2 Hz to 2 MHz
- Accuracy to $\pm 5\%$

HITACHI 100 MHz QUAD TRACE DELAYED SWEEP OSCILLOSCOPE

Model V-1050F

\$1249⁹⁵

(Reg. \$1980)
Probes included.

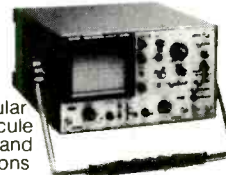

- Large 6" rectangular CRT w/internal graticule
- Delayed alternate and single sweep functions
- Autofocus

Service & Shipping Charge Schedule Continental U.S.A.

FOR ORDERS	ADD
\$25-100	\$4.50
\$101-250	\$6.00
\$251-500	\$8.00
\$501-750	\$10.50
\$751-1,000	\$12.50
\$1,001-1500	\$16.50
\$1,501-2000	\$20.00
\$2,001 and Up	\$25.00

Fordham **800-645-9518**
260 Motor Parkway, Hauppauge, NY 11788
Toll Free
In NY State 800-832-1446

ASK FOR OUR
FREE CATALOG!



Measurements of inductances are very simple. Connect the inductor to the test leads and press the *inductors-value* button. That's all, except reading the basic figure from the red LED display and looking at the right to see whether the reading is in μH or mH .

a diode that is rectifying horizontal from the flyback. These pulses can shade one side of the raster darker than the other, among other symptoms. And AGC capacitors with high ESR can cause instability of various kinds.

One example now about power and heat. Check the Photofacts of most newer color TVs. The low-voltage power has a bridge rectifier from the 120Vac line followed by a large electrolytic, perhaps $330\mu\text{F}$ at +220V rating. The maximum ESR for 200V is 0.80Ω . Imagine an 0.80Ω resistor added between source of voltage and the capacitor's positive terminal. All incoming charging current and all outgoing discharge current must pass through the ESR resistance to the load. The voltage drop across the ESR is low, so little internal heat is generated. But, suppose the ESR was very bad, say 80Ω . Now the charging and discharging currents develop considerable heat. Equally serious is the reduction of the dc output voltage that is reduced by addition of the ESR resistance and by upsetting the peak-reading rectification.

Misleading symptoms

Perhaps you have a hint by now that finding electrolytics having excessive ESRs by analyzing symptoms from the TV screen is just not an efficient plan. Often the symptoms lead a technician to the incorrect circuit or stage.

For troubleshooting these puzzling cases, I recommend a good

scope as the first line of defense to locate the general circuit having the defect. Then an LC tester should be used to test all the capacitors in that area, especially the electrolytics, including the smaller ones used primarily as bypasses.

The scope must be operated when the receiver is operating, while the LC-75 should primarily be used to test out-of-circuit components. This will be discussed later.

Inductance tests

Two different tests for inductances are available in the Sencore LC-75. The dynamic test of inductance operates by applying a constantly varying dc current through the coil under test, and then measuring the ac voltage that is produced across it by the varying current. The second inductance test is an updated ringer test, which will be explained later.

Six automatically selected inductance ranges cover from $1.0\mu\text{H}$ to $9,999\text{mH}$ with an accuracy of $\pm 2\%$ of reading plus the resolution error. As is true of the other LC-75 functions, the LED-readout decimal moves as needed, and annunciator LEDs at the right of the numerical readout show if the reading is in microhenries or millihenries.

In-circuit inductance tests are possible if the circuit resistances are moderately high; that is a change from Sencore's advice with capacitors where they advise out-of-circuit tests only. The operation

manual lists six ranges of permissible in-circuit resistances for 10% accuracy.

These inductance tests are even more simple than the ones for capacitors, because there are no leakage tests. Just connect the test probes to the inductor terminals and press the *inductor-value* button. The display shows the inductance immediately. When the inductor is open, or when the inductance exceeds 10H or when a capacitor is in series with the inductor, the three 8's flash and a constant 0 is seen at the display's right. Remember there must be a dc path through the inductance, or a reading cannot be obtained.

When the inductances are small, the test-lead inductance becomes an appreciable factor in the readings, and therefore should be zeroed. Place the probes approximately where the measurement will be made (remember the former admonition against placing the leads against metal or near strong acV fields). Then short the hook probes together, press the *value* button, and rotate the *lead-zero* knob very slowly until the readout is 00.0 with the minus sign showing rarely. About two seconds are required for each new reading, so move the control a small amount in the correct direction and then wait for the reading before moving the control another slight amount, and so on until the optimum adjustment is located.

Ringings tests

The previous inductance measurement takes advantage of one fundamental about inductances: Varying current through an inductance produces a matching, varying *voltage* across the inductance. Ringing operates this way: A coil-and-capacitor tuned circuit will "ring" for a time at its resonant frequency after it is struck by a pulse. The higher the circuit's "Q," the longer it rings. In the ringer function, the capacitor value is changed to find the one providing the highest reading, but we must consider it the constant, for the inductance is the component that is being tested. Ringing tests are for coils of unknown inductance ratings or for shorted-turns test in vertical and horizontal-sweep yokes, flybacks, and horizontal-driver transformers.

Looking At The Future

- - - From The Past

Copyrighted DIEHL 1986 Amarillo, Texas

The closed loop circuits in late model TV sets are becoming more and more difficult to service. Just when you feel you have a handle on the parts that repeatedly fail in any given chassis, and think to yourself that you have solved your start up and shut down problems for awhile, a totally different string of parts begin to show up in that same chassis that cause the same identical symptom. In spite of the fact that the same symptom is on the screen (usually nothing more than a very quiet, blank screen), the new wave of parts failures turn out to be in an entirely different portion of the horiz, hi-voltage, LV, LV regulator circuit, or in some scan derived B+ source that no one would ever suspect, much less consider.

Before they can even begin to function, many (or most) late model TV sets first require a "start up" B+ pulse for the horiz oscillator, and another such "short term" supply of initial B+ voltage for the horiz driver stage. Both of these "initial" start up pulses must be supplied by the primary low voltage power supply. Specifically, they must originate from some point in the LV supply that is located between the LV rectifiers and the B+ side of the primary winding of the horiz sweep transformer.

Once the horiz osc/driver stages begin to cycle, the secondary side of the flyback must begin to provide its own B+ voltage, which will then be used to **keep** the horiz osc/driver stages running once the initial start up B+ source has been depleted. Thus, as a technician, when it comes to troubleshooting the horiz oscillator or driver stages, you are now dealing with four totally

independent circuits (the start up circuit, scan B+ "run" circuit, the oscillator, and the driver circuit), and not just the horiz oscillator and driver circuit.

But, it doesn't end there!

The low voltage regulator circuit in most late model TV sets will employ any number of shut down sensors. If for example, the video output stage is shorted, the start up circuit will still start the oscillator/driver stages, the horiz output stage will still "cycle" the primary of the flyback, the flyback will still begin producing scan derived voltage, but the secondary winding of the flyback that supplies B+ voltage for the video output stage will be "loaded down" by the shorted video output transistor. That secondary winding will run into magnetic saturation, the entire iron core of the flyback will "saturate", the output level of the flyback will be low, the insufficient output of the flyback will "trigger" any one of four or five LV regulator shut down circuits, the LV regulator will promptly shut down, and, - - - the technician who is witnessing this sequence of events will have no possible way of knowing whether the oscillator failed, the driver failed, the start up circuit failed, the LV regulator, primary B+ or the flyback itself has failed!

It still doesn't end there!

Many late model sets now employ a "sustaining pulse" circuit that takes a 60 hz pulse from the **vertical** output circuit, and applies this same 60 hz pulse to the LV regulator drive circuit.

At first glance, it almost appears that the design engineers are creating these "special effect" circuits just to make service more difficult for field technicians.

- - - NOT TRUE!

In fact, such circuits are nothing less than a stroke of genius once you analyze their purpose and function.

Based on the law of physics, anything that either loads, or unloads one secondary winding of a transformer, will effectively produce the same results at all other secondary windings with regards to voltage output. That is, if you "short out" one winding, you will drastically reduce the voltage output of all other windings. If you "open" a given winding, you will drastically increase the voltage output of all other windings. Its all a matter of volts/amps, which is the primary design criteria of **all** transformers.

This in itself tells you that "opening" or "shorting" a secondary winding that for example feeds the vertical output stage, will have a much greater effect on all other secondary windings, than doing likewise to a secondary winding that supplies nothing more than an agc pulse. **WHY!** Because the vertical output stage requires far more amperage to drive it than does the agc circuit.

Why were sets designed this way?

Imagine a TV set in which all of the circuits, except for the horiz output stage, operate off of a wide assortment of scan derived B+ sources. This same TV set is running along just fine, when suddenly, the vertical output or the R-B-G video output stage becomes open due to an open resistor or transistor.

Continued on page 23

DEFECT	INDUCTIVE VALUE	RINGING CONDITIONS
NORMAL	105mH	76 rings #5 (92 #1)
RECT FIL SHORTED	105mH	03 rings #5 (14 #2)
4 TURNS SHORTED	91mH	08 rings #3 (15 rings #2)
1 TURN OF SOLDER SHORTED	105mH	01 ring #5 (18 rings #2)

Table 1. Usually a *ringing* test will be more sensitive to shorted turns than will an *inductive value* test. This is true for the particular flyback used to obtain these figures.

LC-75 is connected as shown except for a permanent connection of the test probes to flyback primary pins 9 and 3 (plate and B+).

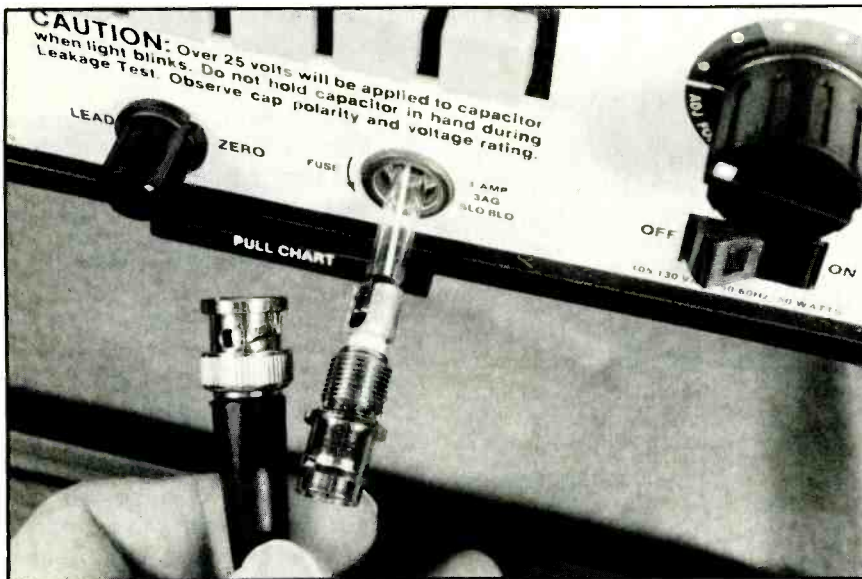

As shown here, the 1A 3AG slow-blow fuse to protect the LC-75 is behind the front panel. The fuse plugs into the back side of a special BNC adapter and the fuse is pressed tightly into place when the adapter is screwed clockwise into the panel. Then the BNC connector (on the Sencore special-test leads) connects to the other BNC connector. If the LC-75 becomes intermittent, check these parts to make certain they are tight. If the LC-75 has a display, but will not give any reading, remove the fuse and check it for continuity, using an ohmmeter (visual inspection is not sufficient).

After the test leads are connected to the flyback, yoke or other inductance, and the *inductor ringing* button pressed, the *ringer impedance-match* knob is rotated through the four positions (for deflection components) or six for other coils, as the technician looks for the position giving the highest reading. Most normal inductances produce more than 10 cycles, but a defective inductance with shorted turns shows fewer than 10 ringing cycles. Shorted turns in one or more of the coils is the most likely cause of a low reading in ringing cycles.

On the ringer *impedance-match*

knob, the four positions at the right (having red background on the panel) are specifically for television yokes and flybacks, while the two at the left (with the blue panel background) have extra sensitivity and are tailored to permit accurate testing of smaller coils. *Do not use these two to test flybacks and yokes, but all six can be used on most non-sweep inductances.*

Ringing tests usually are not successful with transformers having laminated iron cores. Examples are audio transformers, filter chokes and power transformers. Some borderline

cases are explained in the Sencore operation manual.

The ringer at work

Over the years, I have operated many Sencore instruments that incorporated the ringer circuit. The ringing test is excellent, and no one who needs to check inductances for shorted turns ever should be without a ringer.

As a comparison between inductive value and ringing, I tested an old flyback (probably from a monochrome television receiver) with simulated shorted turns. Table 1 shows the inductive value of the transformer's primary, and lists the number of rings during these tests when shorts were placed at various windings.

Only a glance at Table 1 is necessary to see that the ringing system is far more sensitive for finding shorted turns in yokes and flybacks than is the inductive value. The LC-75 has both methods, thus giving you a choice.

In Table 1, the number of rings shown in brackets was obtained when the *impedance-match* knob was turned to No. 1 or No. 2 position (those with the blue background). Of course, these two positions should not be used for television yokes and flybacks, and it is easy to see why: Many bad components will test good when the knob is turned incorrectly to positions No. 1 and No. 2, producing readouts larger than 10 rings.

Incidentally, the ringing reading in the LC-75 is updated regularly, in comparison to some of the previous Sencore instruments that gave one reading and displayed it without change, unless the knob was rotated or the ringer knob released and pushed again.

Other unique tests

Forward-bias current and reverse-leakage current of high-voltage diodes (used as focus or high-voltage rectifiers) can be tested by the LC-75 without additional equipment.

If the SCR-224 accessory is obtained and used with the LC-75, SCRs and triacs can be tested for leakage and controlled conduction.

The distance from one end of a coaxial cable to an open or a short can be obtained by a simple measurement by the LC-75 and a

Continued on page 52

Continued from page 21

In less than a heartbeat, what used to be a +26 volt scan B+ source that supplies the tuner, IF, video, chroma circuit, suddenly surges to something over sixty volts. Should this happen, it doesn't take much imagination to realize what will happen to most (or all) of the solid state devices in all of the stages that are connected to the +26 volt source (which is now producing some + sixty volts)?

On the other hand, if the set had employed a 60 hz "sustaining" circuit for the purpose of supervising the LV regulator, the LV regulator would have immediately shut down as soon as the vertical output stage died, and no surge would have occurred on the +26 volt line.

The application is wide and varied.

Some sets employ as many as ten or eleven totally unrelated shut down circuits. Some of which may be used to shut down the horiz oscillator, others to shut down the LV regulator, and others to shut down the horiz driver. All ten circuits can come into play simultaneously, or they can also be activated on an individual basis.

Some LV regulator drive circuits are known to employ as many as seven totally unrelated shut down circuits, each independently activated by a totally unrelated event (i.e. a shorted video stage, an open vertical stage, excessive hi-voltage, excessive brightness, an inoperative ABL circuit, any type of a short in any circuit that relies on scan derived B+ voltage). A shorted LV regulator in turn may activate yet another shut down circuit that will saturate the base of the horiz driver transistor with positive voltage until all scan sources are dead, and the entire TV set is likewise dead.

Now, - - - let's analyze the above.

A TV set comes into your shop with a "dead set" symptom on its screen:

1. Did the Horiz oscillator die?
2. Did the horiz driver die?
3. Is the LV regulator in shut down?



**1800 TIMES FASTER
... THAN YOU**

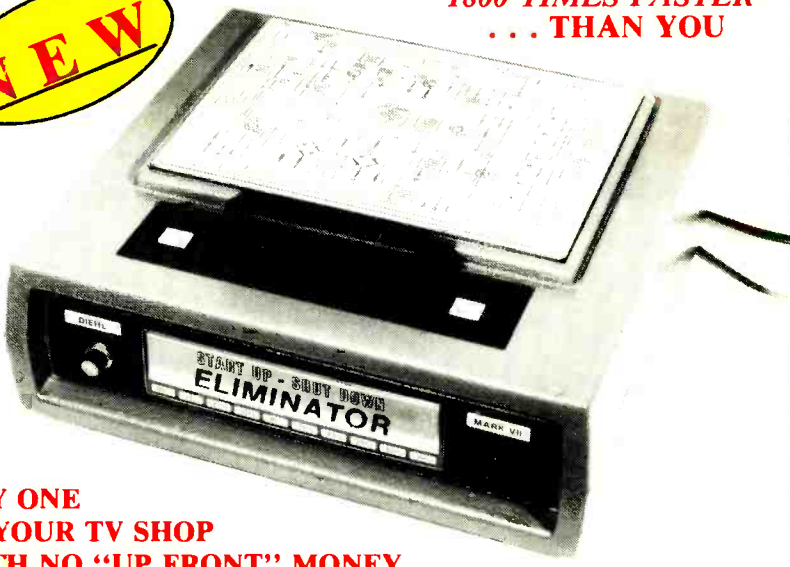

**TRY ONE
IN YOUR TV SHOP
WITH NO "UP FRONT" MONEY**

AS SOON AS YOU PUSH THE TEST BUTTON

The defective component will light up in the Eliminator's generic schematic,

A light will tell you whether that component is open or shorted,

Another light will tell you what effect the defective component has had on the overall circuit (I.E. LV short, inductive short, no

start up, LV reg. shut down, horiz drive shut down, lost scan B+ source etc).

An instruction will light up telling you how to verify the findings of the Eliminator by taking just one voltage reading at a "land mark" test point (without pulling the chassis).

4. Did the LV regulator circuit simply die?

5. Did the horiz osc/driver die, or is one or both of them in shut down?

6. Could the safety capacitor be open?

7. Is the flyback defective, or is it a shorted vertical, video, R-B-G output stage, or the HV multiplier that is causing the flyback to "appear" to be defective?

8. Is the vertical output circuit functional?

9. Did the initial start up pulse occur?

10. Is the scan B+ "run" voltage present?

11. Is the flyback circuit open, shorted, is it simply not being driven, or is the flyback itself just defective?

12. Is the LV regulator working?

13. Is the circuit not working due to a defect in the horiz drive or LV regulator circuit, or is it in shut down due to a short or open condition in a circuit that utilizes scan derived B+?

14. Is the circuit defective?

15. Is the set in shut down?

16. Or could it be that it never really started up in the first place?

17. On the other hand, perhaps it started up; but did not receive any "run" B+ voltage.

The list of questions goes on and on.

In the case where the set is blowing a fuse, is it doing so because of a short in the LV supply? or, is it due to a short in the flyback related circuitry?

Allowing that a short, or, an open circuit almost anywhere in the TV set can cause either overall shut down, or failure to start up, or "failure to run" symptoms (which amount to nothing more than a dead set), and considering that an open or shorted primary LV supply will cause the same symptom, it's sometimes difficult to establish a starting point. It is **literally impossible** for any technician to establish any type of an organized troubleshooting routine, and **virtually impossible** for him to economically complete such repairs without an absolute stroke of luck with regards to "stumbling" over the defective part while chasing the elusive failure (usually in a circular motion).

Continued on page 25

Test your electronic knowledge

By Sam Wilson

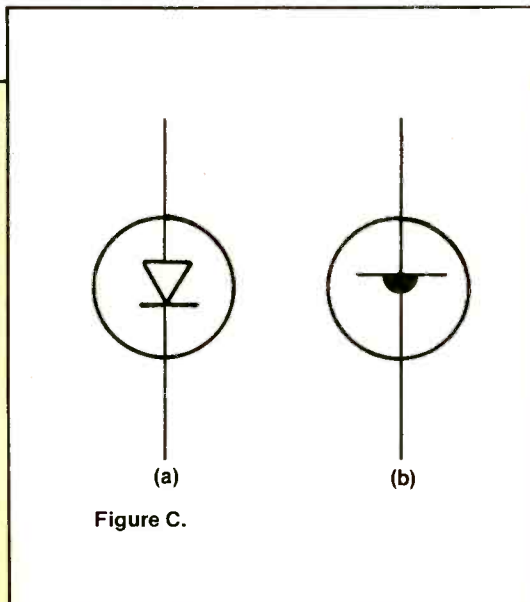
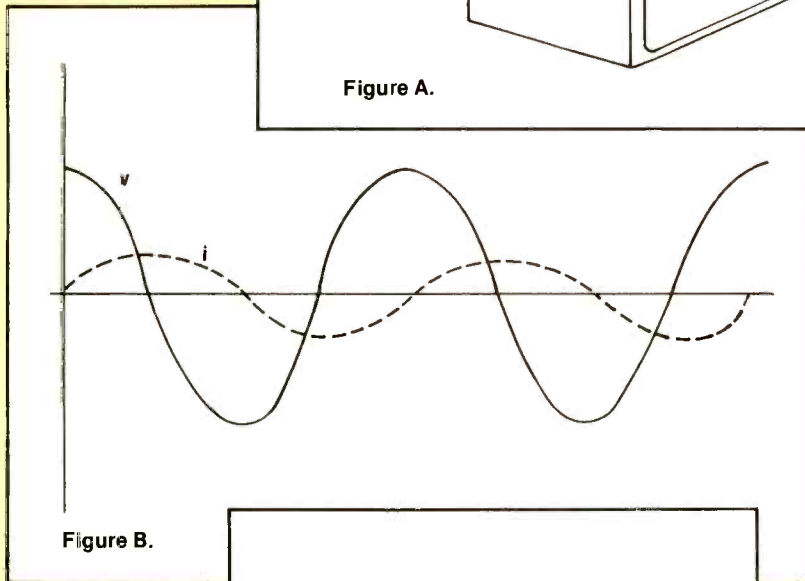
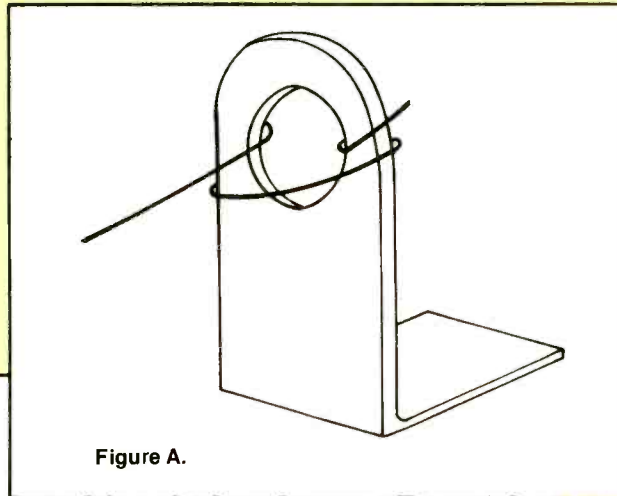

Because of the wide variety of subjects covered, this is one of the more difficult quizzes. A grade of 50% is satisfactory.

1. Disregarding the very strange audio standards, everyone knows that multiplying the sinewave rms voltage by sinewave rms current gives

A.) peak power in a purely resistive circuit.

B.) average power in a purely resistive circuit.

2. An ac 60Hz sine wave voltage is connected across a pure resistance. The power waveform has a frequency of

A.) 60Hz.

B.) 120Hz.

3. You are going to set up a circuit that converts a circle radius value to a perimeter value. For the highest speed you would use a

A.) PLE lookup table.

B.) cosine resolver.

4. When soldering a wire to a terminal, it is important to make a good mechanical connection like the one shown in Figure A.

A.) This statement is wrong.

B.) This statement is correct.

5. A certain dc motor is connected to a lead acid battery. There is no mechanical load connected to its shaft. It runs faster and faster until it destroys itself.

A.) It is a shunt-wound dc motor.

B.) It is a series-wound dc motor.

6. Which of the following is used for testing a low-frequency transmitter with a minimum amount of radiation?

A.) Ground plane

B.) Dummy antenna

C.) Foldback thermionic load

7. The maximum amount of coupling between two coils is called

A.) Unity coupling.

B.) Maxiflux.

8. The voltage and current in a certain circuit are related as shown in Figure B. The circuit is

A.) inductive.

B.) capacitive.

9. Which of the symbols in Figure C represents a tunnel diode?

10. Name the three buses used in microprocessors.

Answers are on page 59.

Continued from page 23

In order to effectively troubleshoot any bonifide start up, or shut down, or any type of flyback circuit related failure in a modern TV set, you would have to **simultaneously** determine whether the start up pulse occurred, whether the oscillator/driver circuits are functional, whether the scan B+ "run" voltage is being provided, whether any shorted or open conditions exist on the secondary side of the flyback, whether the LV supply is open or shorted, whether the LV regulator is working, and whether or not "how many" of the above circuits are capable of working with each other!

Unless you gathered every bit of the above information simultaneously, the problem or defect would come into play, and you would not be able to **ACCURATELY** gather any of it. In order to demonstrate this, consider a TV set that starts up with a burst of hi-voltage then promptly dies. Which circuit is defective, the osc/driver, the start up circuit, scan B+ circuit, LV regulator circuit, vertical circuit, primary LV supply, safety capacitor, flyback, or is it nothing more than a shorted R-B-G video output circuit? Could it be a shorted CRT?

The fact is, any of the above circuits could cause the exact same symptom that was given, and we defy any human technician to come up with any type of systematic method of separating the possibilities of failure. Like we said, unless you can gather **all** of the above information simultaneously, and do so during the very first one hundredth of one second of circuit operation, you will not be able to gather **any** of it, on **any** type of a systematic basis.

If you have been having problems with start up and shut down circuitry, at least now you know why. You should also be aware at this point that every technician who is working on them is also "donating" much of his time for the same reasons.

In order to solve the above problems once and for all, we at **DIEHL** designed a digital computer that does indeed gather all of the above information, plus some ten

times as much "other" information within the first one hundredth of a second of operation.

In the next one hundredth of a second it will compare everything that did, and everything that did **not** happen in the entire low voltage, hi-voltage, horiz osc/driver, LV regulator, start up, shut down, flyback transformer, and any circuit that relies on scan derived B+ (including external and internal HV multipliers and picture tube), including the vertical, video, R-B-G video output circuits (from a current consumption standpoint), then organize and discern all of the above with absolute 100% accuracy.

In the next one hundredth of a second, our latest diagnostic computer will tell you exactly and precisely which type of a circuit condition, or circuit failures exist. For example, it will tell you if the LV supply is open or shorted, if the LV regulator is open or shorted, if the main filter capacitor in the LV supply is open or shorted, if the pin cushion, H. yoke, centering diode, H. yoke discharge capacitor, or damper diode is open or shorted,

likewise for the primary winding of the flyback.

It will then tell you whether the initial start up circuit, horiz osc/driver, and scan derived "run" B+ source is open or shorted (including any rectifier, resistor, capacitor, or transformer in this circuit). It will pinpoint shorted horiz driver transistors. It will also pinpoint any open or shorted rectifier or filter capacitor in any B+ path (scan or otherwise). The Mark VII-E will also tell you if either the LV regulator or the horiz osc/driver is in shut down. Not only that, it will also tell you **why** it is in shut down.

If any type of a short or open exists in any portion of the flyback circuitry, it will pinpoint that condition.

In the event it encounters an open safety capacitor or damper diode, it will automatically "bridge in" its own substitution component, light a lite telling you that it has done so, then continue with its scan as though nothing were wrong regarding the safety cap or damper

Continued on page 27



WITH AN ELIMINATOR
There Is No Such Thing
... As A Dog

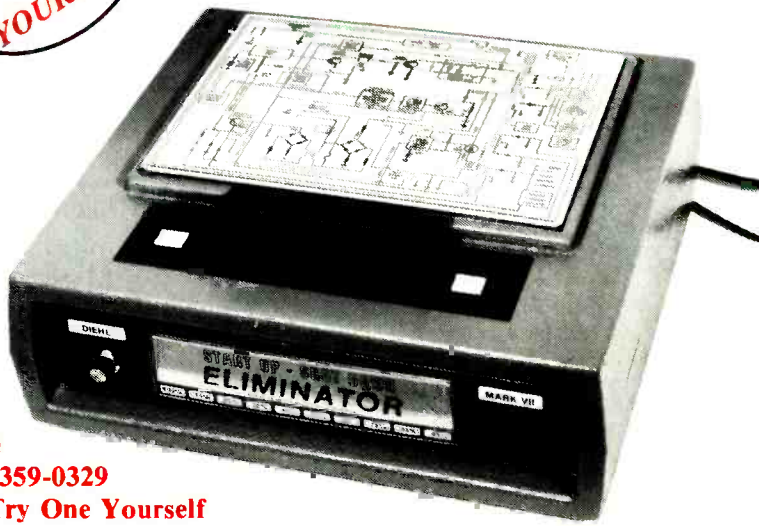

Phone
(806) 359-0329
And Try One Yourself

FOR START UP/SHUT DOWN PROBLEMS
OR ANY LV, HV, FLYBACK RELATED FAILURE

In any eight hour day, one Eliminator will accurately identify more defective components (ones that will actually repair the TV set), than any ten technicians who are presently working anywhere in the TV service industry.
(Even if it is being operated by an amateur)
Rather than "mumble to yourself"
"IT CAN'T BE DONE"
Why not try one in your own shop

Test equipment for disk drives

By Allan Hughes

Floppy disk drives, the mechanical marvels of virtually every computer system, do require periodic maintenance. Usually ignored until there is a problem, they are subject to both mechanical wear and possible circuit degradation throughout the life of the drive.

Although you can test drives in the system using a software program, you're limited by the fact that the drive has to be working properly to load the program.

Allan Hughes is President of AVA Instrumentation, Inc. of Ben Lomond, CA.

Most currently available drive-test programs are designed only to tell you if the drive needs servicing; the actual servicing is not usually performed with the software program.

Two levels of service

With the drive removed from the system, there are two distinct levels of service that are necessary: head alignment and drive functional (read/write) testing. Head alignment refers to the five most common adjustments on

every drive: radial alignment, azimuth adjust, motor speed, index and track 0 sensor position. Functional testing determines whether the drive reads and writes properly with a minimum of errors. A drive can be perfectly aligned and adjusted and yet not be capable of reading and writing data when installed in the system. Conversely, a drive may have excellent system performance and yet be so far out of alignment that other disks cannot be interchanged with it.

Selecting the right test equipment is straightforward once you have identified which level of service you wish to perform. Head alignment can be performed easily with a simple drive exerciser, analog alignment diskette and a dual-channel oscilloscope. Functional testing is best performed by a disk-drive tester, which has many test capabilities not available using system diagnostics, such as measuring window margins, asymmetry and step rates. All testers on the market duplicate the functions of an exerciser for head alignment.



The primary function of a floppy disk drive exerciser is to allow a service technician to select track, head, start/stop the drive motor, etc., for the purpose of head alignment and/or troubleshooting.

A workbench equipped with a floppy disk drive tester (left) and a floppy disk drive exerciser, for servicing disk drives.



ADVERTISEMENT

Our New Electronics Assembly Plant

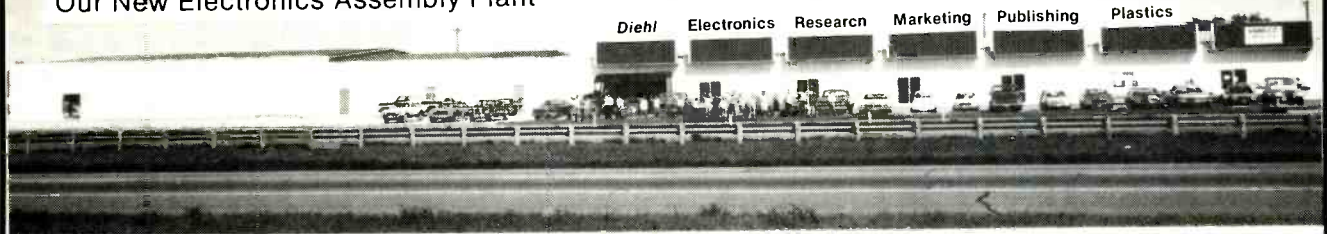

In August of this year, *Diehl* doubled its capacity to manufacture diagnostic computers. We would like to take this opportunity to

thank our 15,000 plus loyal customers who made it all possible. Without **Y O U**, we could not have survived.

Continued from page 25

diode. (without our computer, you would lose the horiz output transistor and perhaps the damper diode at the very first sign of an open safety capacitor).

Not only will our computer tell you the exact nature of the failure with regards to precisely which circuit has failed, and the condition that has been induced, it will also (in that same one hundredth of one second), tell you exactly **which** component in that circuit has failed.

In order to make absolutely certain that you do not think the previous sentence contained some sort of a typographic error, we will now repeat it.

Our new Mark VII-E Diagnostic Computer will pinpoint the exact component that has failed, and do so within one hundredth of one second of operation.

Furthermore, it will not only pinpoint the exact **nature** of the circuit failure, pinpoint the exact **component** that has failed, and tell you whether that component is now open or shorted, - - - it will also give you a brief **instruction** that will tell you how to **prove** beyond any possible doubt that the decisions made by the Mark VII-E are 100% correct with regards to which type of circuit condition exists, and exactly which component has failed. This instruction will in every instance tell you how to prove the findings of the Mark VII-E by measuring nothing more than the collector of just one "land mark" test point (i.e. the collector of any R-B-G video output transistor).

The mark VII-E works on any TV set that employs either an N-P-N transistor, or a single SCR as a horiz output device. No programming is required. Everything you need

comes with it. Almost no instructions are required. The top of its case houses an 8"x11" display panel which contains a generic schematic for LV, LV regulator, H. osc/driver, output, flyback, yoke, scan B+ circuits, etc., etc. All instructions are contained within the generic schematic, but not visible until they are illuminated by the VII-E.

As soon as you push the test button, the defective component will lite up amber, the circuit condition will lite up red, and the instruction will lite up yellow. As a result, the Mark VII-E may well be the only piece of major test equipment that you can take out of its box and immediately begin using (without reading anything), since it provides its own instructions as you go.

With regards to exactly which circuit has failed, and exactly what type of circuit condition exists, the Mark VII-E can **never** be wrong. As to exactly which component has failed, it may occasionally miss by no more than one or two components. If so, the TV set will pass the test that is given by the instruction. In this event, the next time you push the test button, the Mark VII-E will automatically "step" to the next lower "odds" circuit, lite the next likely suspect component, and a brand new instruction for proving or disproving the new "suspect" component. In almost no instance will you ever have to so much as look at more than three components. By the time the Mark VII-E has "stepped down" to its third odds circuit, it is greater than 99% accurate. The "odds of probability" are displayed on the front panel of the computer for each

individual finding.

To operate a Mark VII-E, simply plug the TV set into its female AC outlet (front panel), interface the horiz output device, push the test button, and read the generic schematic. If you hook it up wrong, the "hook up" light on its front panel will come on, and the Mark VII-E will shut itself and the TV set off until you correct the error.

For obvious reasons we call it the "**Eliminator**". If you earn your living repairing TV sets - - - You need one! They sell for only \$3,495⁰⁰ and are now available. Visa and Master Card welcome, short term/long term financing is available. With approved credit, we'll even let you try one in your own shop for fifteen days with no up front money. Call (806) 359-0329 for more information, or write **DIEHL** Industries, 6661 Canyon Drive, Amarillo, Texas 79110.

Diehl will pay \$100,000⁰⁰ to any technician, engineer, factory representative, or to any **group** of technical personnel, who can effectively compete against an eliminator with regards to speed and accuracy, no matter how much "other" test equipment they care to use, no matter how much it costs (We'll even give them two to one odds). This is a serious offer. If you or anyone you know would like to take us up on it, we will be pleased to send you an application to do so. When it comes to start up and shut down related circuitry, nothing on earth will compete with **DIEHL'S** Mark VII-E Eliminator. - - - Nothing! For that very reason, you truly need one.

**Wait till you see Diehl's Mark VII
VIDEO ANALYZER**

Circle (10) on Reply Card

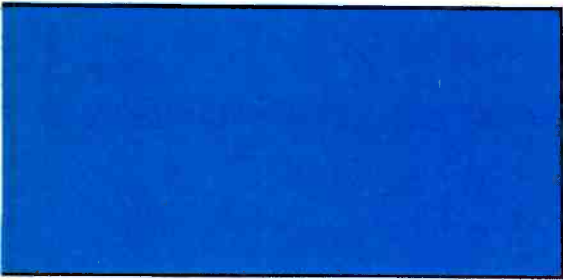

Performing a head alignment

The block diagram in Figure 1 illustrates the test set up to perform a head alignment on a 5¼-inch floppy disk drive. With the possible exception of the dc power supply voltages used, all sizes of drives use this same setup.

Typical examples of oscilloscope waveforms from an analog alignment diskette are shown in Figures 2 through 4. The actual adjustment procedures and specifications vary from drive to drive, and can be found in the drive maintenance manual. Figure 2 shows the *cat's eye* radial alignment pattern, where the ratio of lobe amplitude determines the adjustment needed. Here the lobe ratio is approximately 75%. Perfect alignment is 100%, or both lobes equal. Figure 3 shows the time from index to burst, with the

scope triggered on the leading edge of the index pulse. Here the time at 50µs/div is shown at 160µs, which would fall within the nominal specifications for many drives.

Figure 4 shows three sets of azimuth bursts, each written at a different angle. The drive maintenance manual explains the azimuth measurement and adjustments.

Exerciser vs. tester

There is much confusion over the use of terms *exerciser* and *tester*. Fundamentally, exercisers do not process or analyze the read data coming from the disk drive. Although they may or may not be microprocessor-based, their primary function is to allow a service technician to select a track, head, start/stop the drive motor, etc., for

Figure 1. A floppy disk drive is connected to an exerciser and oscilloscope for head alignment.

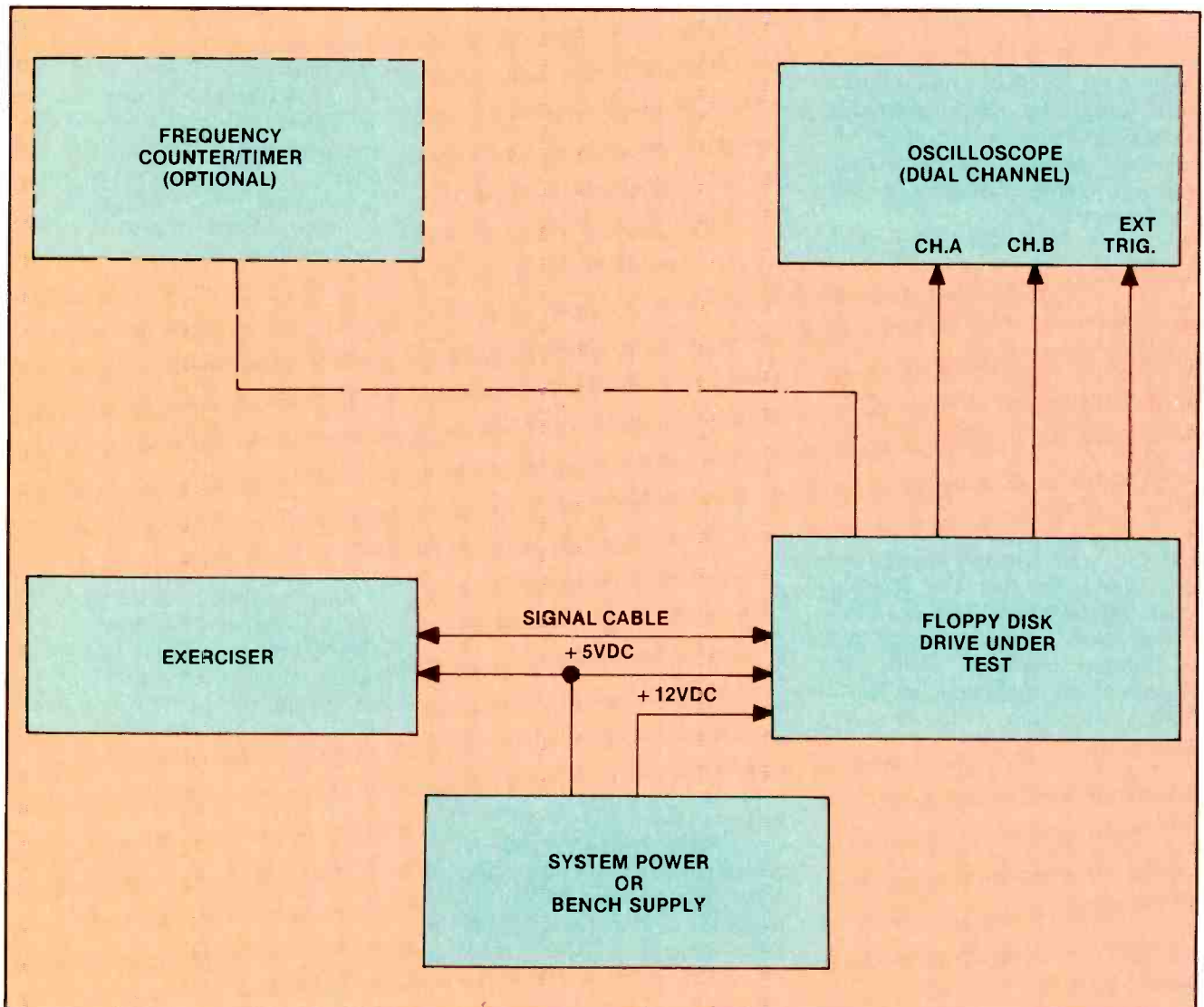

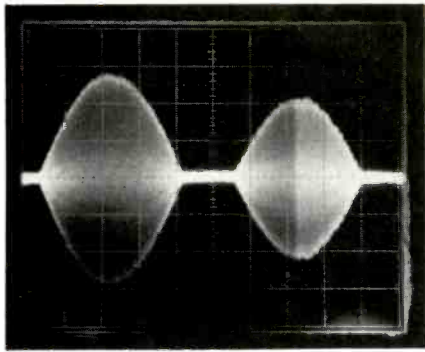

Figure 2. This is the "cat's eye" pattern seen on the oscilloscope during radial alignment.

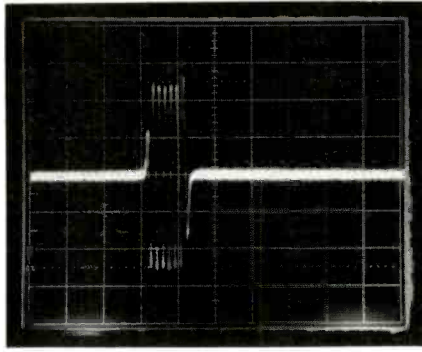

Figure 3. This scope trace shows the time from index to burst with the scope triggered on the leading edge of the index pulse.

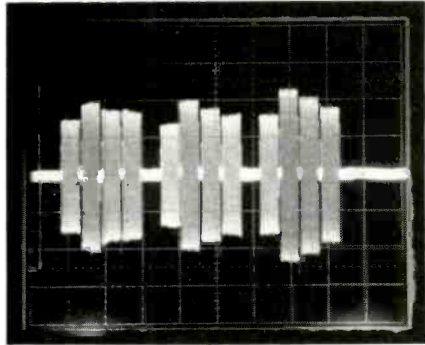

Figure 4. This scope pattern shows three sets of azimuth bursts, each written at a different angle.

the purpose of head alignment and/or troubleshooting. Most exercisers also have the capability of writing simple 1F or 2F (unformatted) data on a blank diskette to verify the operation of the drive-write circuitry.

Testers, also called *analyzers*, are microprocessor-based instruments that can format and read an entire diskette and report errors as they are found. Most testers have printer (hard copy) capabilities, and can test multiple

PCBs NEED THESE

If you're involved in printed circuit boards, you should be involved with Chemtronics. Because we have the advanced technology you need for degreasing, flux removal, solder masking, conformal coating, gold finger protection, intermittent troubleshooting, desoldering, and maintaining today's sophisticated electronic devices.

To get involved with Chemtronics, write or call us today for technical information and the name of your nearest authorized distributor.



Chemtronics

Keeping Pace With Advanced Technologies

Chemtronics Inc., 681 Old Willets Path, Hauppauge, NY 11788
800-645-5244 In NY 516-582-3322 © 1986 Chemtronics Inc.

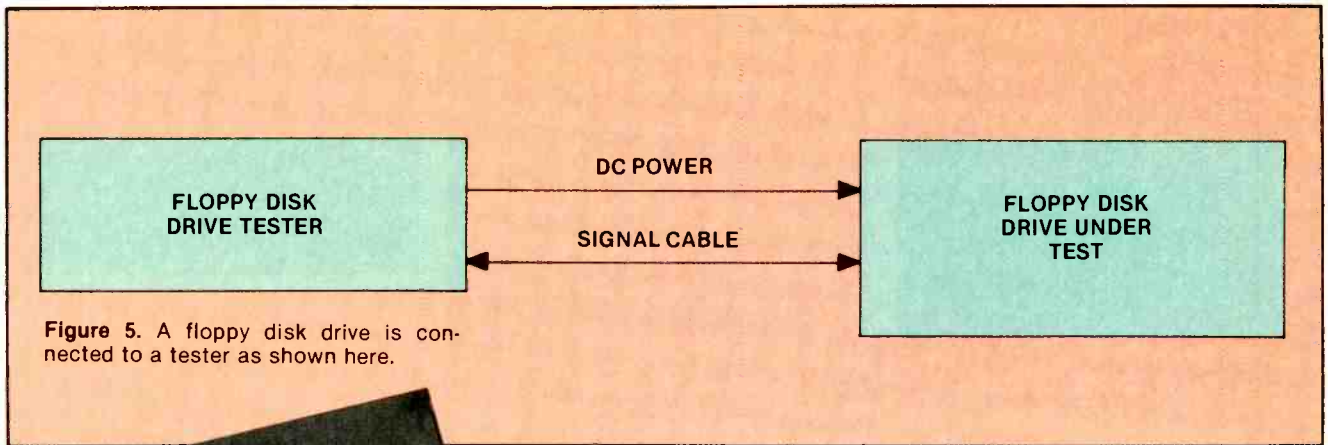
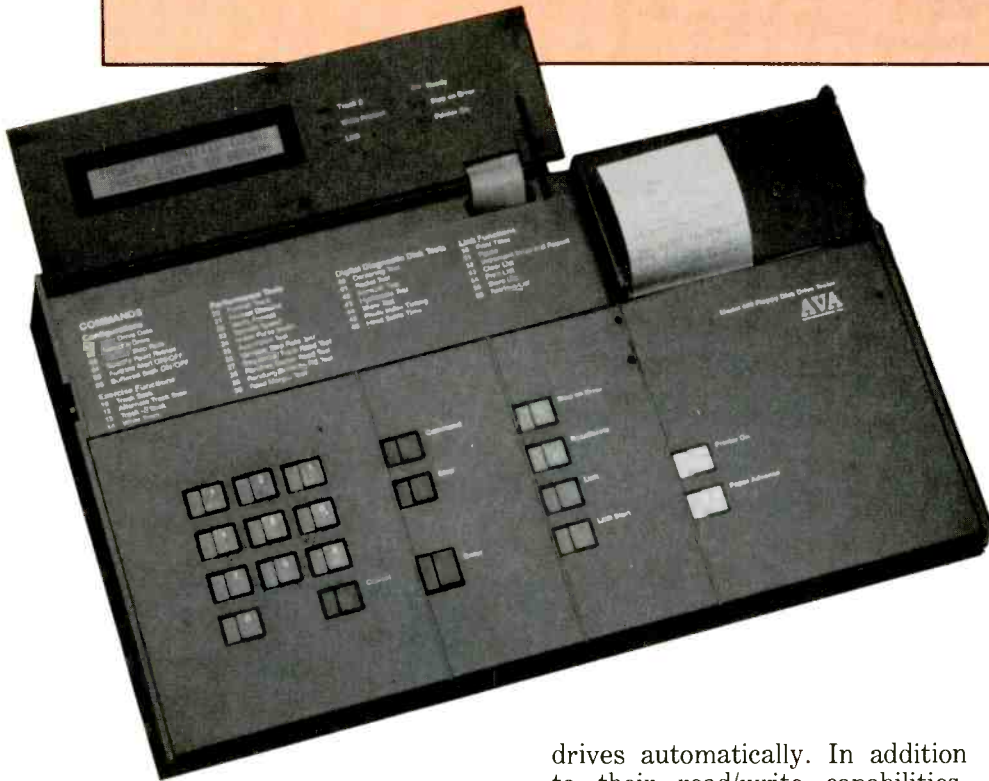

Figure 5. A floppy disk drive is connected to a tester as shown here.



A floppy disk drive tester can format and read an entire diskette and report errors as they are found. Most testers have printer capability and can test multiple devices automatically.

drives automatically. In addition to their read/write capabilities, testers offer the user the ability to perform read (window) margin testing and other parametric testing to determine whether the drive meets manufacturer's specs.

Most testers have the capability of measuring head alignment without an oscilloscope, either by duplicating the analog functions of a scope, or by utilizing a digital alignment diskette, such as Dysan's DDD. The advantages are a greatly simplified setup, as shown in Figure 5, and the ability to record on a printer the results of all tests.

Costs vs. benefits of exercisers

Exercisers are typically priced from \$200 to \$500, with the higher priced models offering significant additional features. In addition to the obvious features such as size, weight and ease of use, you should ask about the following:

- How is it powered? Most exer-

cisers take dc power from the disk drive power supply.

- What sizes of drives are supported? Eight-inch, 5¼-inch, 3½-inch, for example.
- What interfaces are supported? Most drives found in PCs share the same standard industry interface. How about non-standard interfaces such as Apple, Atari, Commodore, Victor?
- Will it support Winchester (ST 506 interface)?
- Does it allow for floppies with more than 100 tracks, such as Kodak 3.3Mbyte?

Costs vs. benefits of testers

Testers are priced between \$1,000 and \$8,500. As with the exercisers, there are many differences between models. Here's what to look for:

- Does it provide power for the drive under test? If yes, what size drive?
- What sizes and interfaces are supported? Apple?
- Can it test multiple drives? Is extra hardware required?
- Is it programmable? By the user?
- Does it have pass/fail limits?
- Is a printer built in, or is a printer port available?
- Are Margin and Asymmetry testing supported?
- What methods (digital or analog) are employed to measure head alignment?

A final word

Many exercisers are labeled testers when in fact they are not. Look at the features, in particular the data handling ability, to determine the best choice for your application.

ES&T

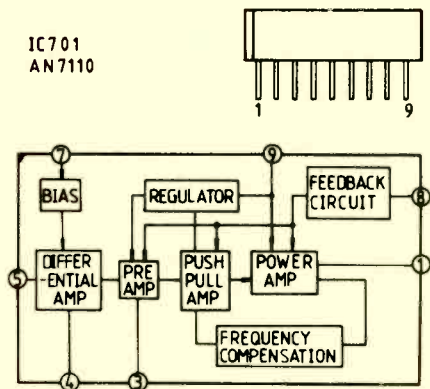

Product safety should be considered when component replacement is made in any area of a receiver. The shaded areas of the schematic diagram designate the components in which safety is of special significance. It is recommended that only exact cataloged parts be used for replacement of these components.

Use of substitute replacement parts that do not have the same safety characteristics as recommended in factory service information may create shock, fire, excessive x-radiation or other hazards.

This schematic is for the use of qualified technicians only. This instrument contains no user-serviceable parts.

The other portions of this schematic may be found on other Profax pages.

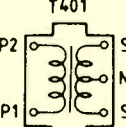
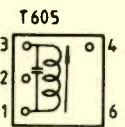
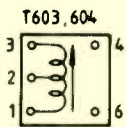
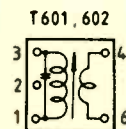
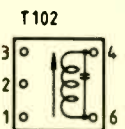
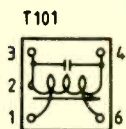
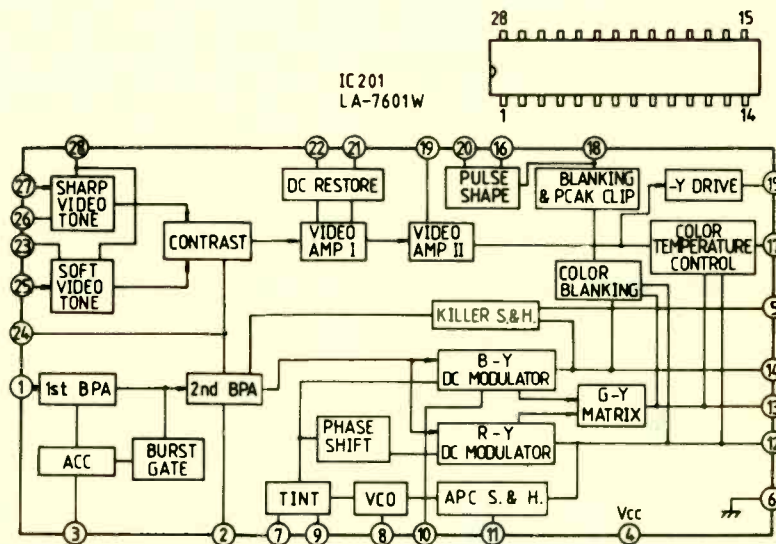

- 2SC1730L
- 2SA733P,Q
- 2SC945P,Q
- 2SC1675K
- 2SC2228A

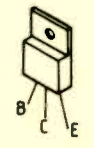
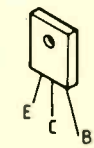
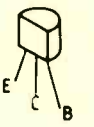

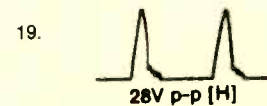
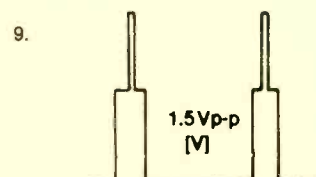
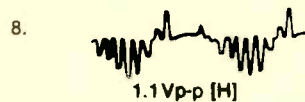
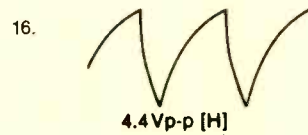
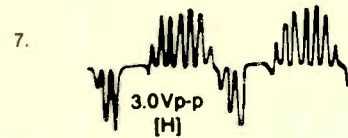
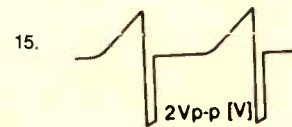
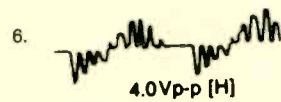
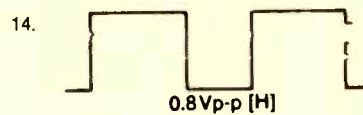
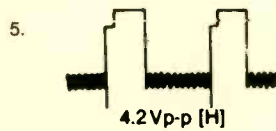
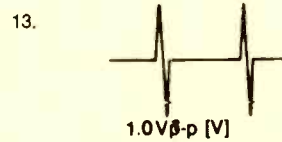
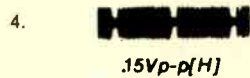
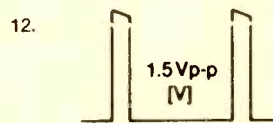
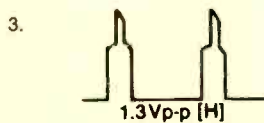
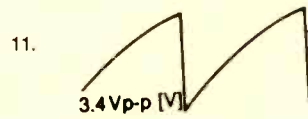
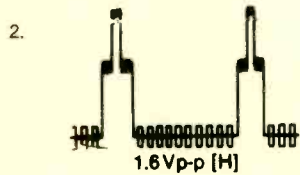
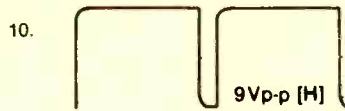
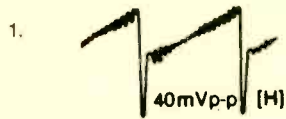

These illustrations are the waveforms observed on the oscilloscope screen when the oscilloscope probes were connected to the test points on the signal circuit board corresponding to the numbers on the schematic diagram.

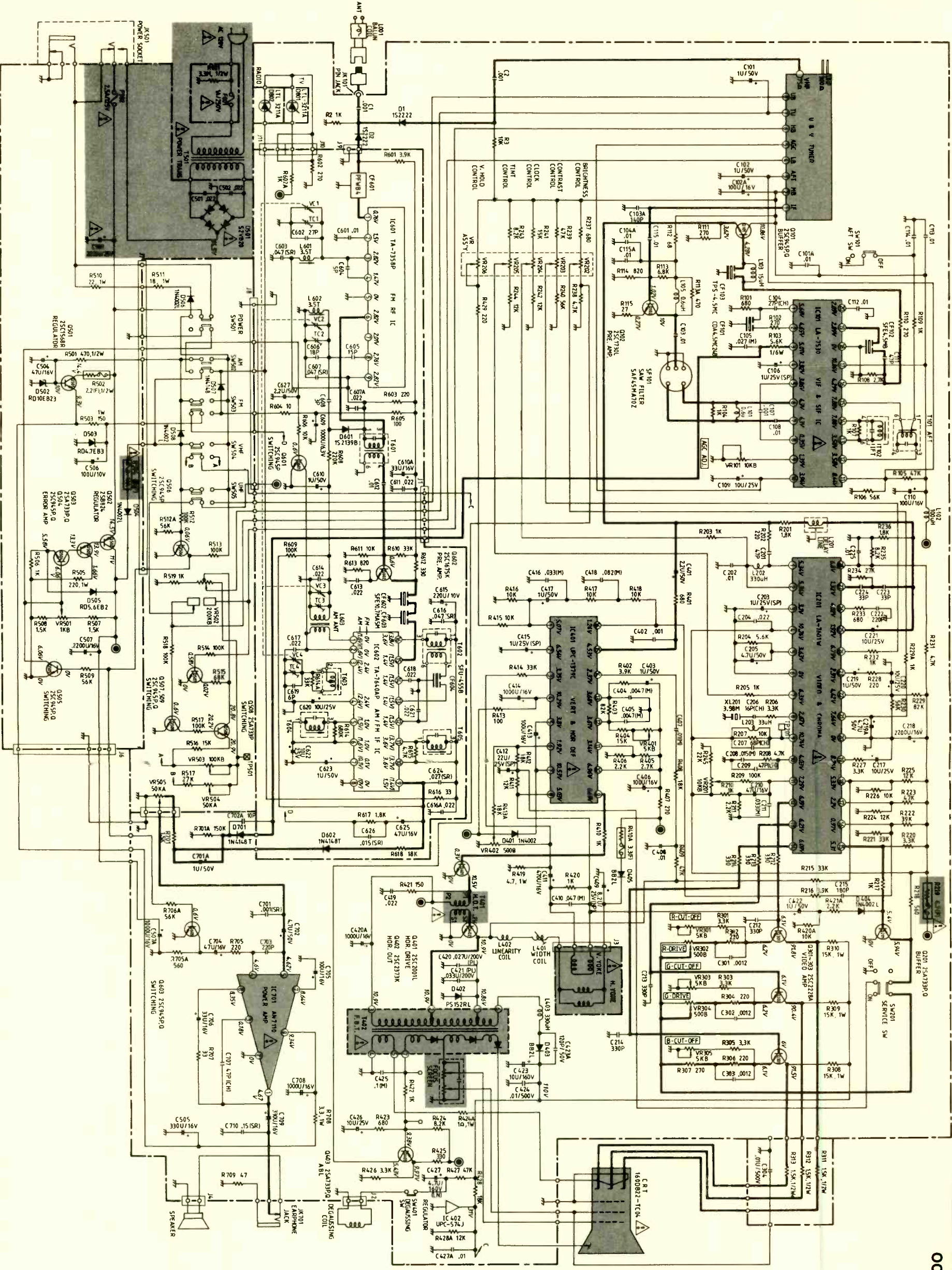

Product safety should be considered when component replacement is made in any area of a receiver. The shaded areas of the schematic diagram designate the components in which safety is of special significance. It is recommended that only exact cataloged parts be used for replacement of these components.

Use of substitute replacement parts that do not have the same safety characteristics as recommended in factory service information may create shock, fire, excessive x-radiation or other hazards.

This schematic is for the use of qualified technicians only. This instrument contains no user-serviceable parts.

The other portions of this schematic may be found on other Profax pages.

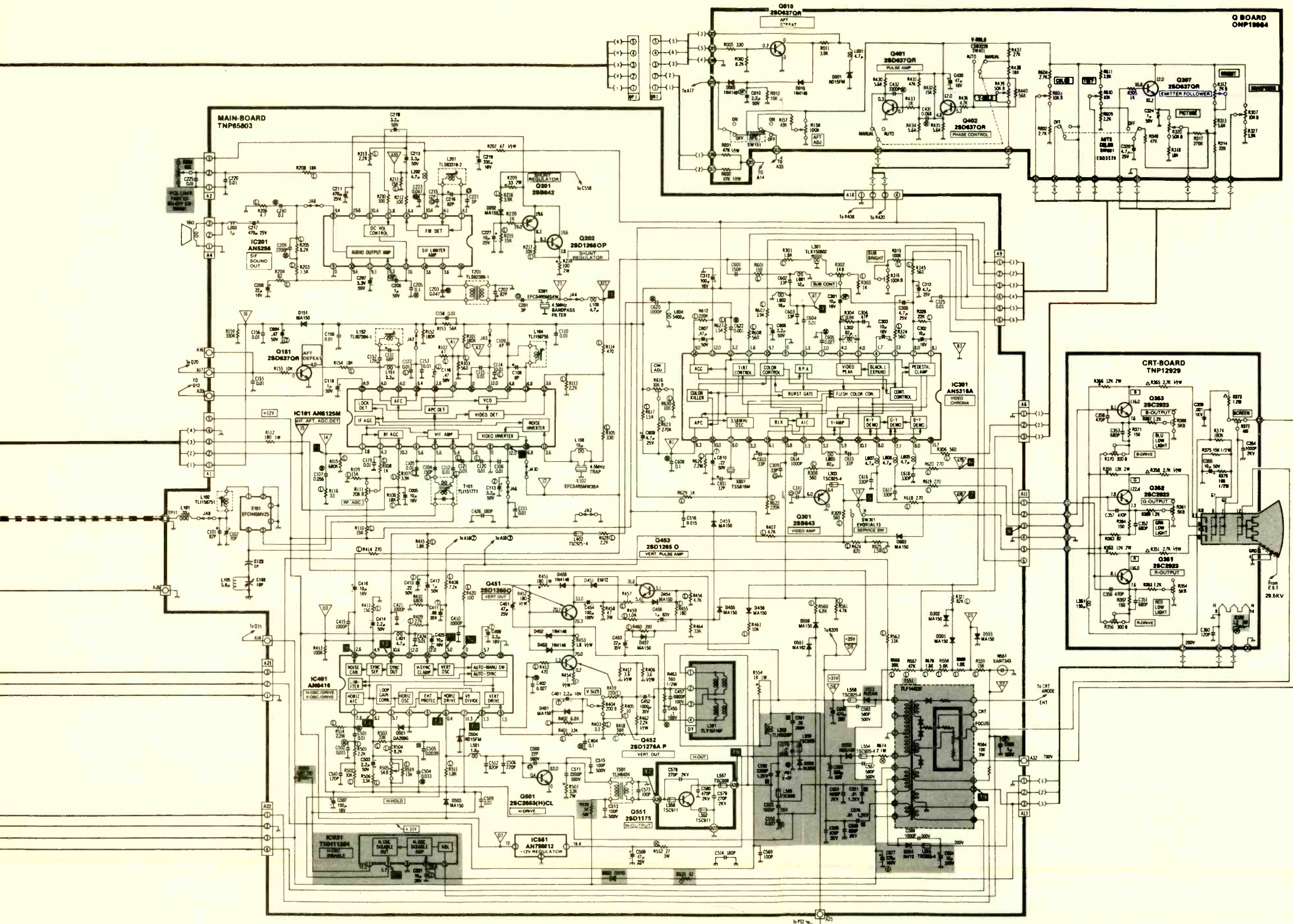

Product safety should be considered when component replacement is made in any area of a receiver. The shaded areas of the schematic diagram designate the components in which safety is of special significance. It is recommended that only exact cataloged parts be used for replacement of these components.

Use of substitute replacement parts that do not have the same safety characteristics as recommended in factory service information may create shock, fire, excessive x-radiation or other hazards.

This schematic is for the use of qualified technicians only. This instrument contains no user-serviceable parts.

The other portions of this schematic may be found on other Profax pages.

This schematic is for the use of qualified technicians only. This instrument contains no user-servicable parts.

The other portions of this schematic may be found on other Profax pages.

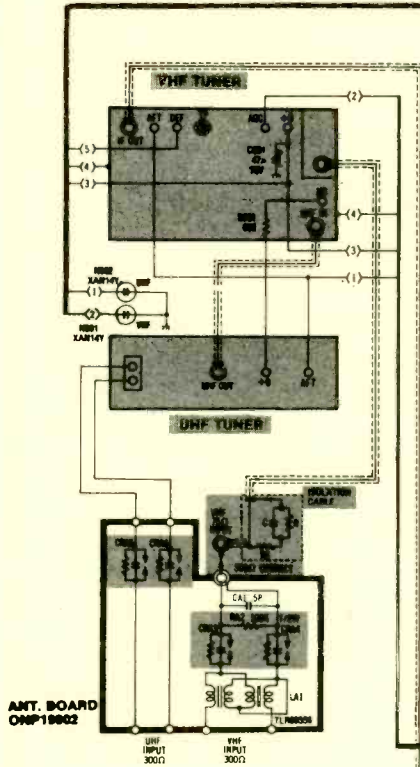

Product safety should be considered when component replacement is made in any area of a receiver. The shaded areas of the schematic diagram designate the components in which safety is of special significance. It is recommended that only exact cataloged parts be used for replacement of these components.

Use of substitute replacement parts that do not have the same safety characteristics as recommended in factory service information may create shock, fire, excessive x-radiation or other hazards.

NOTES

1. RESISTOR

All resistors are carbon 1/4W 5% resistor, unless otherwise noted.

2. CAPACITORS

Capacitor values less than 1 In μ F, others In PF.

3. VOLTAGE MEASUREMENTS

Except where noted, taken from point indicated to chassis with calibrated DVM.

Voltage readings are nominal and vary $\pm 10\%$ on active devices depending on signal strength and content.

Supply voltages are all nominal.

AC input to receiver 120V, CONTROLS AT NORMAL setting. Some voltage readings will vary with associated central settings.

Where two voltages are shown, they represent conditions in special voltage note in area affected.

4. WAVEFORM MEASUREMENTS

Taken with a standard gated rainbow type color-bar pattern. Receiver adjusted for normal viewing as in transmitted air signal.

All video and color waveforms taken with a wideband scope and a probe with low input capacity (10 to 1). Shape and peak-to-peak amplitudes may vary depending on calibration, type of test equipment used and control settings.

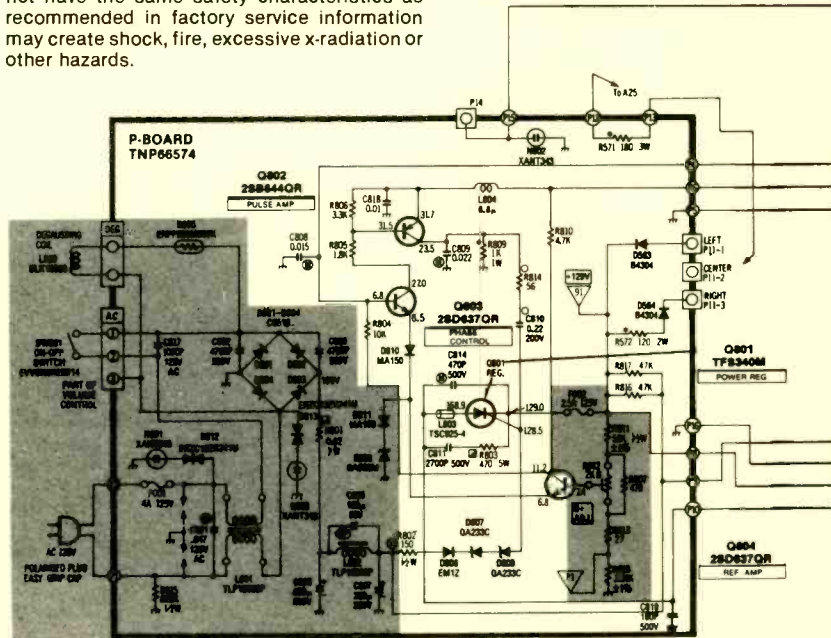

OCTOBER 1986

Schematic No.

GE
B&W TV, X110 chassis 2091

GE
TV/AM/FM clock radio 2092

Product safety should be considered when component replacement is made in any area of a receiver. The shaded areas of the schematic diagram designate the components in which safety is of special significance. It is recommended that only exact cataloged parts be used for replacement of these components.

Use of substitute replacement parts that do not have the same safety characteristics as recommended in factory service information may create shock, fire, excessive x-radiation or other hazards.

This schematic is for the use of qualified technicians only. This instrument contains no user-serviceable parts.

The other portions of this schematic may be found on other Profax pages.

IC101 LA-7530

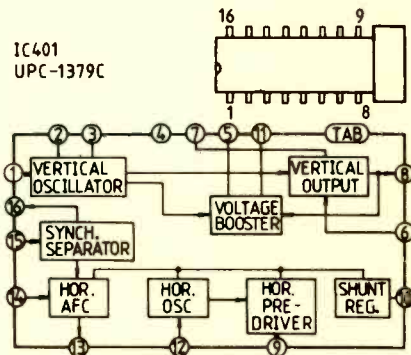
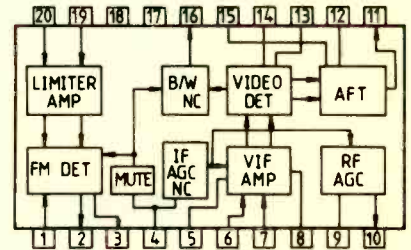

IC601 TA-7358P

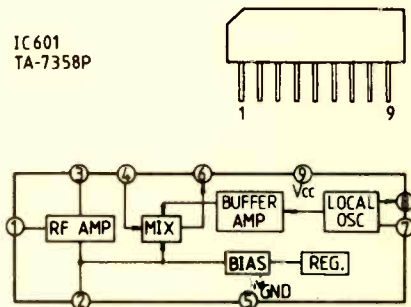

IC602 TA-7640AP

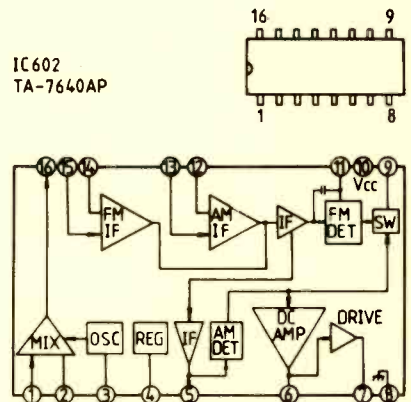

Seeing digital circuit operation with a logic analyzer

Oscilloscope or logic analyzer?

When given the choice between using an oscilloscope or a logic analyzer, most people will choose an oscilloscope. Why? Because a scope is more familiar to most users. There is one on virtually every technician's bench, and it is relatively easy to use. It is one of the most *general purpose* of all electronic instruments. However, it has some shortcomings that limit its usefulness in some applications. A logic analyzer may yield more useful information in many of these applications. However, because a logic analyzer is tuned to the digital world, it doesn't have as broad usage as an oscilloscope. Because of some overlapping of capabilities between a scope and logic analyzer, either may be used in some cases. How do you determine which is better for your application? The next few paragraphs give some basic guidelines.

When should I use a scope

- When you need to see small voltage excursions on your signals.
- When you need high time-interval accuracy.

Generally, an oscilloscope is the instrument to use when you need high vertical or voltage resolution. To say it another way, if you need to see every little voltage excursion, like those of Figure 1, the bottom waveform, you need a

scope. Many scopes, including the new generation digitizing ones, also can provide very high time-interval resolution. That is, they can measure the time interval between two events with very high accuracy. Overall, an oscilloscope is to be used when you need parametric information.

When should I use a logic analyzer?

- When you need to look at information on a bus.
- When you need to trigger on a pattern of highs and lows on several lines and see the result.
- When you need to see lots of signals at once.

Logic analyzers grew out of oscilloscopes. They present data in the same general way that a scope does; the horizontal axis is time, the vertical axis is voltage amplitude. But a logic analyzer does not provide as much voltage resolution, or time interval accuracy as its cousin, the oscilloscope. It can capture and display eight or more waveforms at once, something that scopes cannot do. A logic analyzer also can trigger on patterns of highs and lows on these waveforms. So when do you use a logic analyzer? When you need to look at more lines than your oscilloscope can show you, provided you can live without ultra-precise time interval information. If you need to look at every little transition on the waveform, a logic analyzer is not a good choice.

Logic analyzers are particularly useful when looking at time relationships or data on bus, e.g. a

You need to look simultaneously at the inputs and outputs of a 16-bit counter to determine a timing error and you have only a 2-channel scope. How do you look at them all? You've just developed timing diagrams for a board full of digital circuitry. How do you verify them? An intermittent glitch appears to occur on one of the data lines of your microprocessor system, causing the processor to get incorrect data. You can't trigger on just the glitch with your oscilloscope. What do you use to capture it?

With the wrong tool, solving these kinds of problems can be time-consuming. Being a hero may depend on knowing which tool can get the job done quickly. For the above problems, the tool is a logic analyzer.

This article is intended as a quick course in logic analyzers to cut down on the time needed to learn this new instrument. It doesn't cover many detailed measurements, but does give you a good idea of what a logic analyzer can do. Because we are all pressed for time in our jobs, we wanted to provide you with a reasonably short, simple article that doesn't take a lot of time to read but still covers the basics. We talk about questions like "Why should I bother with a logic analyzer?" and "What will one do for me?" It will help you to understand what contributions can be expected of any analyzer.

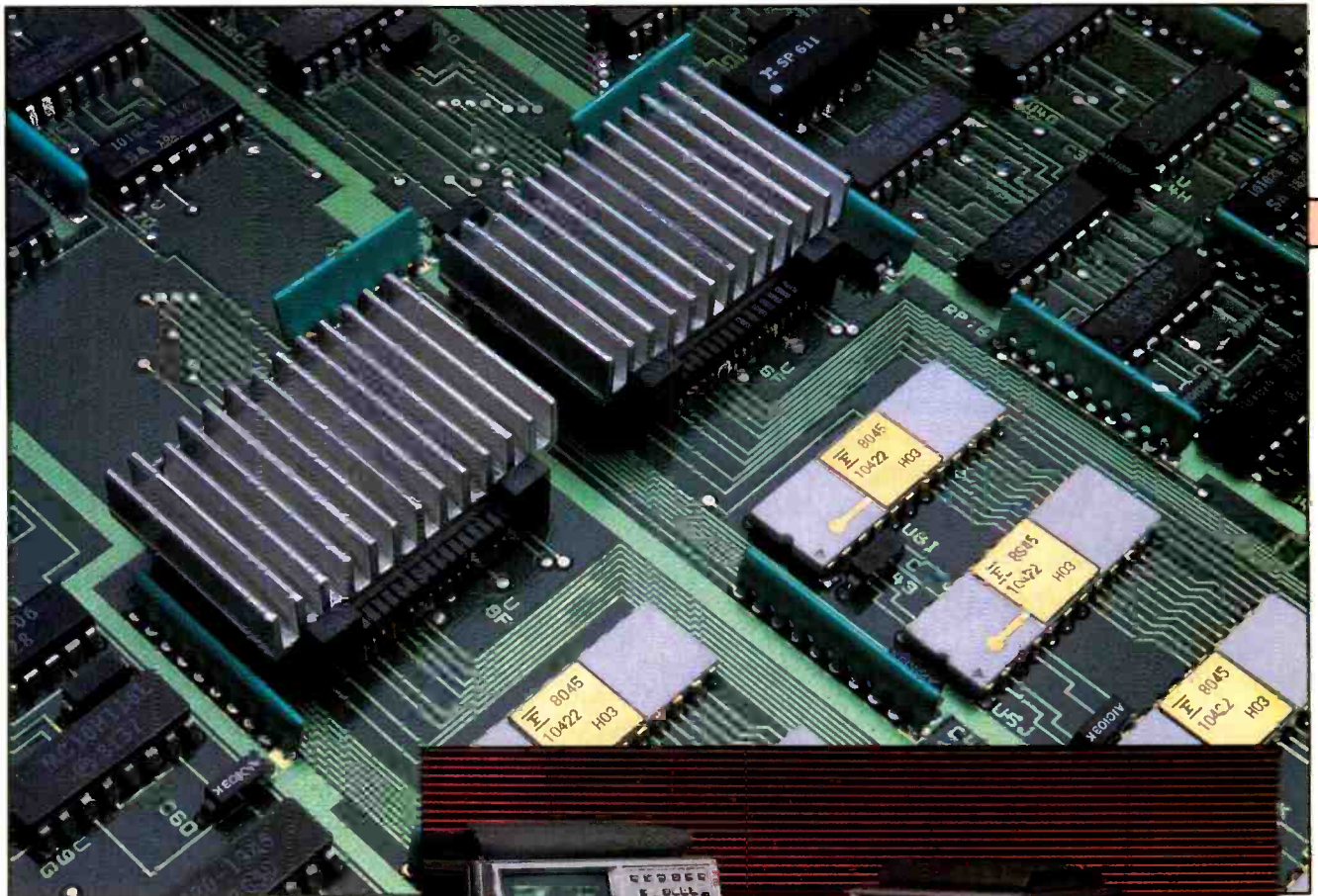

Analysis of digital circuitry frequently requires the use of a logic analyzer, rather than an oscilloscope.



Logic analyzers give the user information about the timing of digital signals, and about the state of logic devices.

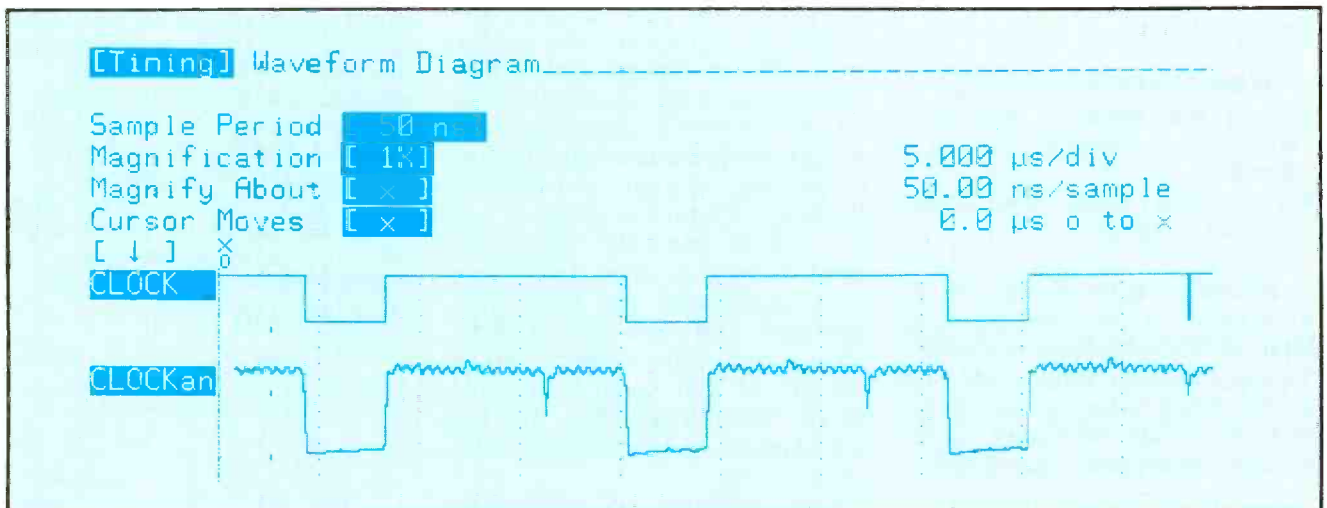

Figure 1. If you need to see every small voltage excursion, as in the bottom waveform, you need an oscilloscope. If you're interested in waveform patterns and need to look at a number of lines at once, the logic analyzer may be your choice.

microprocessor address, data or control bus. It can decode the information on microprocessor buses and present it in a meaningful form (more on this when we describe state analyzers). Generally, when you are interested in timing relationships among many signals and need to trigger-on patterns of logic highs and lows, the logic analyzer is a good choice.

What's a logic analyzer?

Most logic analyzers are really two analyzers in one. The first part is a timing analyzer, while the second part is a state analyzer. Each has specific functions that will be discussed in the following sections.

What's a timing analyzer?

A timing analyzer is the part of a logic analyzer that is analogous to an oscilloscope: They can be thought of as close cousins. The timing analyzer displays information in the same general form as a scope, with the horizontal axis representing time and the vertical axis as voltage amplitude. Because the waveforms on both instruments are time-dependent, the displays are said to be in the *time-domain*.

Sampling the input signals

A timing analyzer works by sampling the input waveforms to determine whether they are high or low. It cares about only one voltage-threshold. If the signal is above threshold when it is sampled, it will be displayed as a 1 or high by the analyzer. By the same criterion, any signal sampled that is below threshold is displayed as a zero or low. From these sample points, a list of ones and zeros is generated that represents a 1-bit picture of the input waveform. As far as the analyzer is concerned, the waveform is either high or low—no intermediate steps. This

Exclusive, triple patented dynamic cap and coil analyzing . . . guaranteed to pinpoint your problem every time or your money back



with the all new LC75 "Z METER 2"
Capacitor Inductor Analyzer
Patented \$995

The "Z METER" is the only LC tester that enables you to test all capacitors and coils dynamically — plus, it's now faster, more accurate, and checks Equivalent Series Resistance (ESR) plus small wire high resistance coils.

Eliminate expensive part substitution and time-consuming shotgunning with patented tests that give you results you can trust every time. Test capacitor value, leakage, dielectric absorption, and ESR dynamically; with up to 600 volts applied for guaranteed 100% reliable results — it's exclusive — it's triple patented.

Save time and money with the only 100% reliable, in- or out-of-circuit inductor tester available. Dynamically test inductors for value, shorts, and opens, automatically under "dynamic" circuit conditions.

Reduce costly parts inventory with patented tests you can trust. No more need to stock a large inventory of caps, coils, flybacks, and IHVTs. The "Z METER" eliminates time-consuming and expensive parts substituting with 100% reliable LC analyzing.

Turn chaos into cash by quickly locating transmission line distance to opens and shorts to within feet, in any transmission line.

Test troublesome SCRs & TRIACs easily and automatically without investing in an expensive second tester. The patented "Z METER 2" even tests SCRs, TRIACs, and High-Voltage Diodes dynamically with up to 600 volts applied by adding the new SCR250 SCR and TRIAC Test Accessory for only \$148 or FREE OF CHARGE on Kick Off promotion.

To try the world's only Dynamic LC Tester for yourself, CALL TODAY, WATS FREE, 1-800-843-3338, for a FREE 15 day Self Demo.

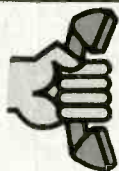

Call Today Wats Free 1-800-843-3338

SENCORE

3200 Sencore Drive
Sioux Falls, SD 57107
605-339-0100 In SD Only

*innovatively designed
with your time in mind.*

Circle (12) on Reply Card

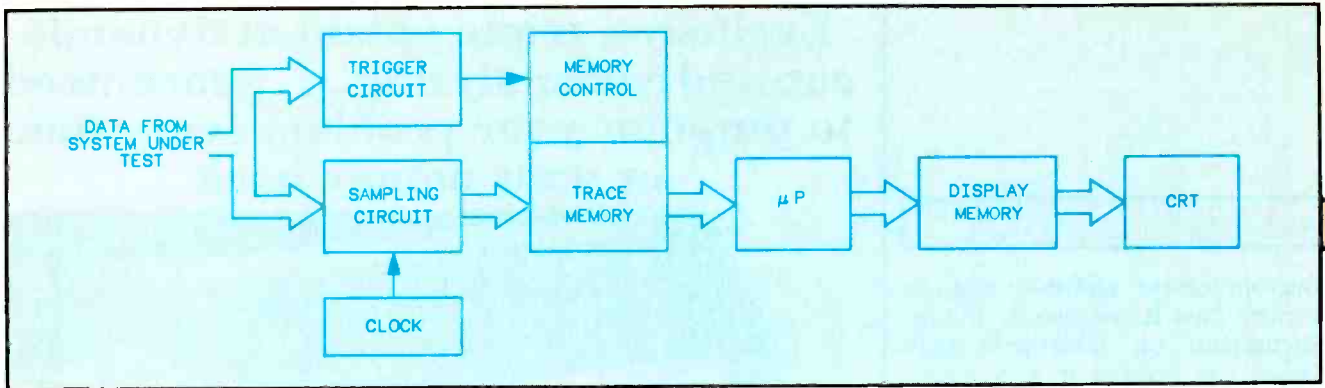

Figure 2. A timing analyzer works by sampling the input waveforms to determine whether they are high or low. It is concerned with only one voltage threshold.

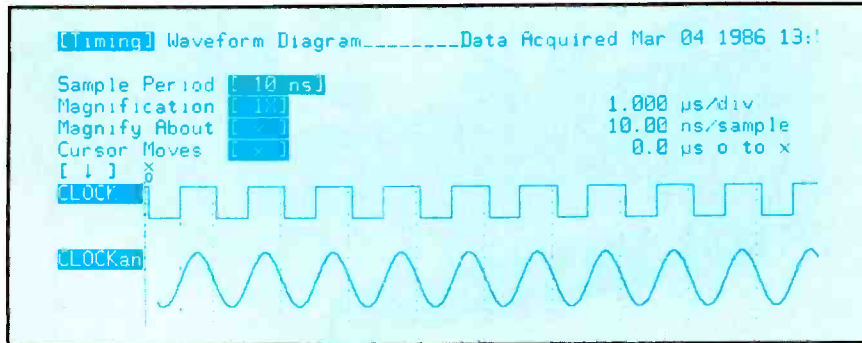

Figure 3. These displays are actually the same signal (a sine wave) displayed by a digitizing scope and a timing analyzer.

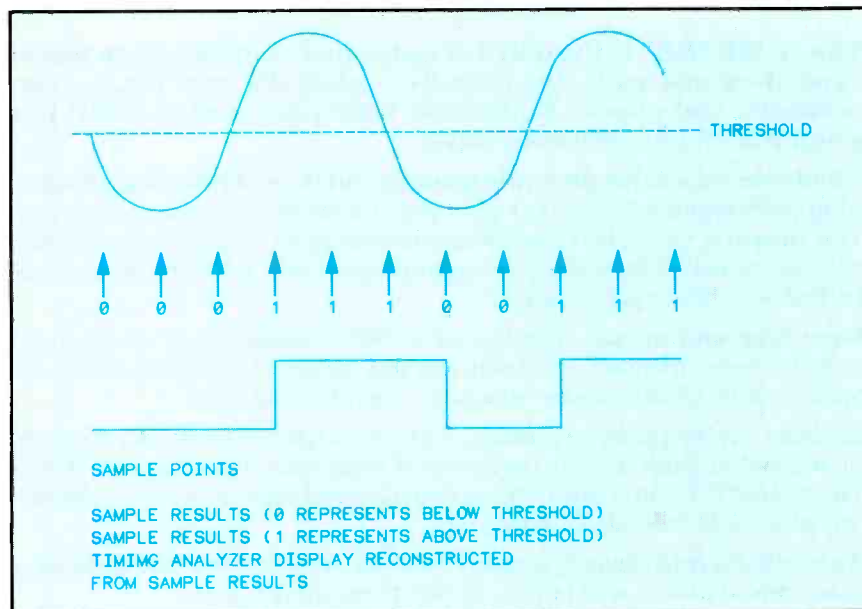

Figure 4. This analysis shows how the sampling process of a logic analyzer turns a sine wave into a square wave.

list is stored in memory and also used to reconstruct a 1-bit picture of the input waveform, as shown in Figure 2. A timing analyzer is like a digitizing scope with only one bit of vertical resolution. With one bit of resolution, you can display only two states, high or low.

Notice the display of Figure 3. These displays are actually the same signal (a sine wave) displayed by a digitizing scope and a time analyzer.

Because the timing analyzer does not reproduce all of the voltage levels, it displays a high/low representation it has created from its sample points. If you put a sine wave into a timing analyzer, you get a square wave. Figure 3 shows in more detail what actually happens.

This tendency to square everything up would seem to limit the usefulness of a timing analyzer. We should remember, however, that it is not intended as a parametric instrument. If you want to check rise time of a signal with an analyzer, you are using the wrong instrument. But if you need to verify timing relationships among several lines by seeing them all together, a timing analyzer is the logical (no pun intended) choice. For example, imagine that we have dynamic RAM in a system that must be refreshed every 2ms. To ensure that everything in memory is refreshed within that 2ms, a counter is used to count up sequentially through all rows of the RAMS and refresh each. If we want to make certain that the counter does indeed count up through all rows before starting over, a timing analyzer can be set to trigger when the counter starts and display all of the counts. Parametrics are not of great concern here—we merely want to check that the counter counts from 1 to N and then starts over.

When the timing analyzer samples an input line, it is either high or low. If the line is at one state (high or low) on one sample and the opposite state on the next sample, the analyzer knows that the input signal transitioned at sometime in between the two samples. It doesn't know when, so it places the transition point at the

Analyze defective waveforms faster, more accurately, and more confidently — every time or your money back

next sample, as shown in Figure 5. This presents some ambiguity as to when the transition actually occurred and when it is displayed by the analyzer. Worst case for this ambiguity is one sample period, assuming that the transition occurred immediately after the previous sample point.

Choosing a sample rate

As an analyzer samples the input lines, the sample points are developed by an internal clock. The period of the sampler can be selected by the user. Because the analyzer is sampling asynchronously to the system under test from direction of this internal clock, a long sample period results in an inaccurate picture. That is because the sampled lines may change many times in between sample points, as you can see in Figure 6. If you need more resolution, the sample period should be kept short.

However, faster sampling fills the internal memory of the analyzer more quickly than a slower one. For instance, suppose you select a sample period of 500ms and that your analyzer can store 1,024 sampled points for each waveform. You can capture and store 512 seconds ($500\text{ms} \times 1,024$) worth of data. This may be fine for some very low rep rate signals but in most systems a lot can go on in 500ms that the analyzer wouldn't capture. If you change the sample period to 10ns, the memory could store $10.24\mu\text{s}$ of data with much greater resolution. The down side is that this may not be a large enough window on your data to find a particular problem you are looking for. All of this means that you should select a sample period that shows you what happens on all lines without filling up the analyzer's memory with unnecessary data. As a starting point, you could determine the shortest pulse width possible on any line and choose a sample period that is less than the width of

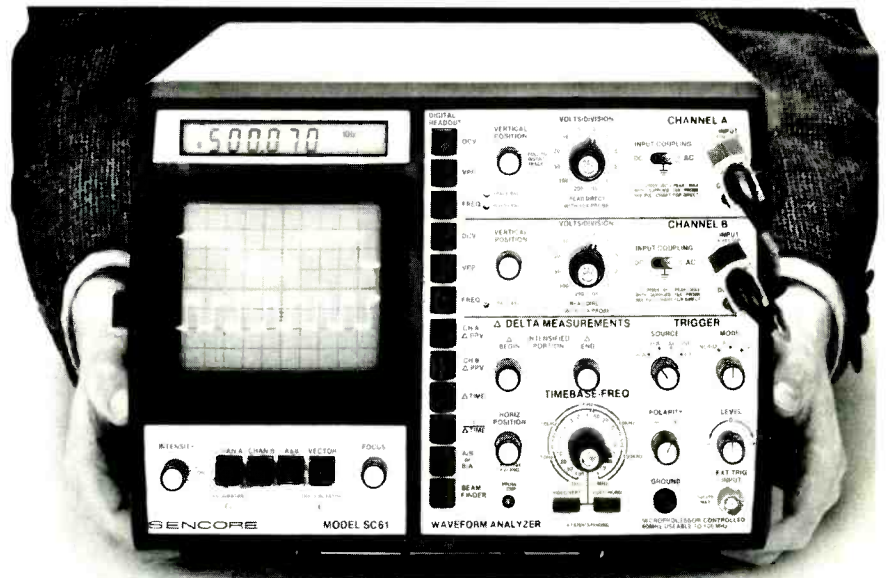

with the SC61 Waveform Analyzer
Patented \$2,995

If you value your precious time, you will really want to check out what the exclusively patented SC61 Waveform Analyzer can do for you. 10 times faster, 10 times more accurate, with zero chance of error.

End frustrating fiddling with confusing controls. Exclusive ultra solid ECL balanced noise cancelling sync amplifiers, simplified controls, and bright blue dual trace CRT help you measure signals to 100 MHz easier than ever.

Accurately and confidently measure waveforms from a tiny 5 mV all the way to a whopping 3,000 V without hesitation with patented 3,000 VPP input protection — eliminates expensive "front end" repairs and costly equipment downtime.

Make only one circuit connection and push one button for each circuit parameter test: You can instantly read out DC volts, peak-to-peak volts and frequency 100% automatically with digital speed and accuracy. It's a real troubleshooting confidence builder.

Confidently analyze complex waveforms fast and easily. Exclusive Delta measurements let you intensify any waveform portion. Analyze glitches, interference signals, rise or fall times or voltage equivalents between levels; direct in frequency or microseconds.

Speed your digital logic circuit testing. Analyzing troublesome divide and multiply stages is quicker and error free — no time-consuming graticule counting or calculations. Simply connect one test lead to any test point, push a button, for test of your choice, for ERROR FREE results.

To see what the SC61 can do for your troubleshooting personal productivity and analyzing confidence, CALL TODAY, WATS FREE, 1-800-843-3338, for a FREE 15 day Self Demo.



Call Today Wats Free 1-800-843-3338

SENCORE

3200 Sencore Drive
Sioux Falls, SD 57107
605-339-0100 In SD Only

*innovatively designed
with your time in mind.*

Circle (13) on Reply Card

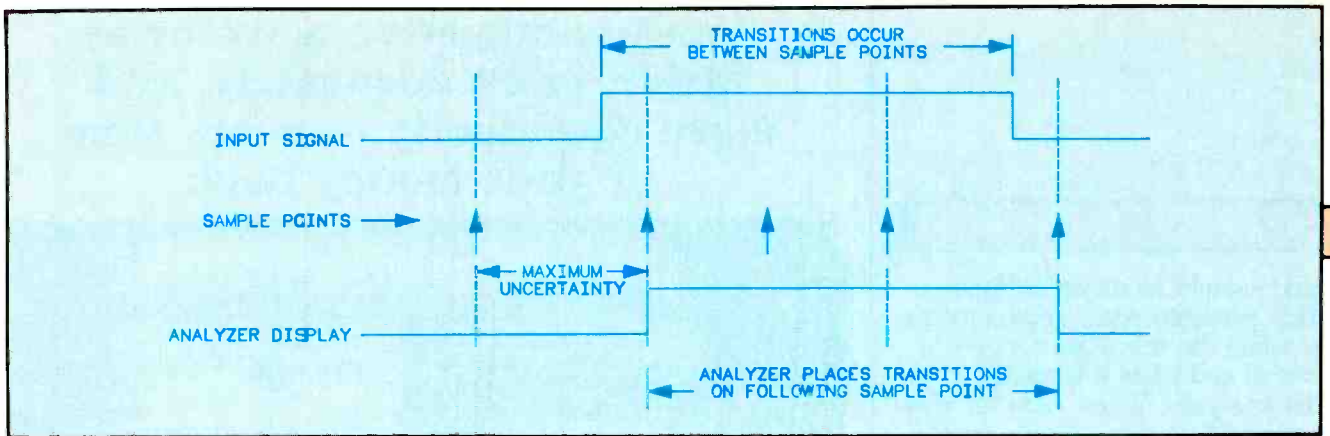

Figure 5. It is important to select the proper sampling rate in order to avoid ambiguity in interpreting the information captured.

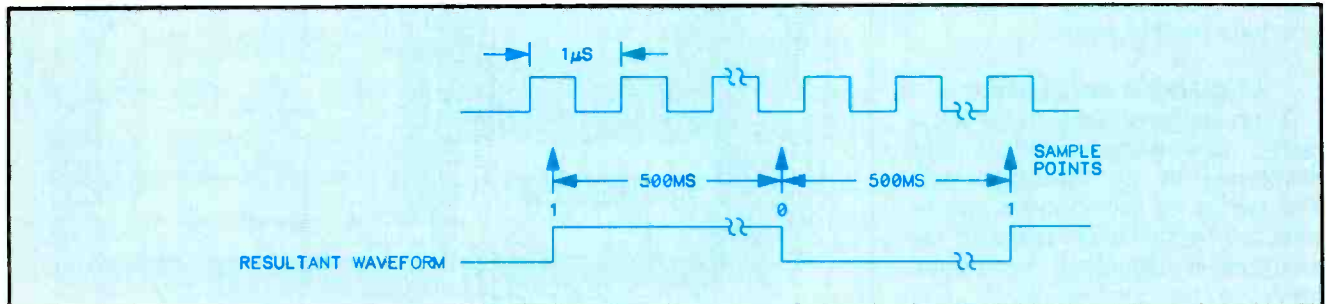

Figure 6. If the sample period is long compared to the period of the waveform being sampled, inaccuracy may result because the sampled lines may change many times in between sample points.

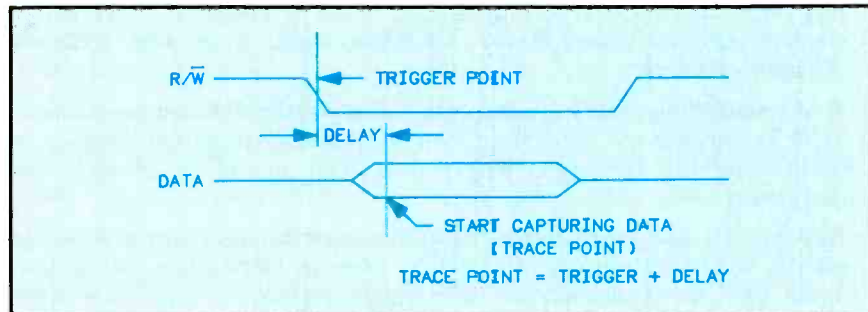

Figure 7. You may wish to begin capturing data at some time after the trigger point. This point, equal to the trigger point plus the delay, is called the "trace point."

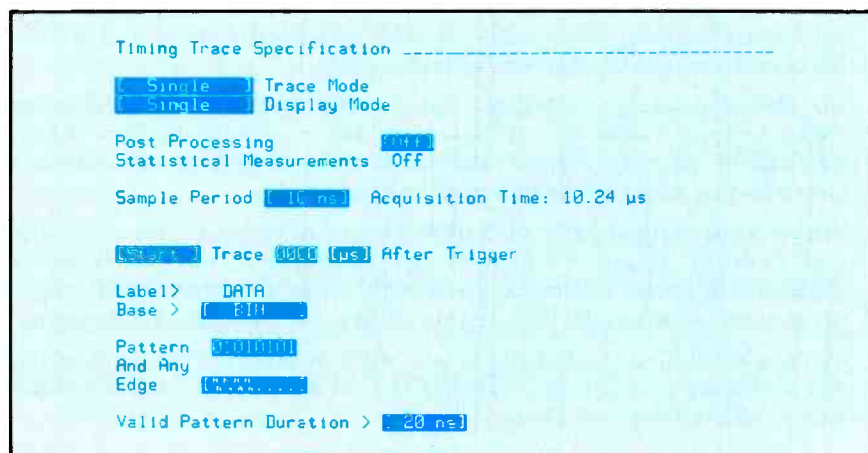

Figure 8. This logic analyzer display shows that the analyzer has been told to start capturing data when channels 0, 2, 4, and 8 are high (logical 1), and when channels 1, 3, 5, and 7 are low (logical 0). This instruction is revealed in the *pattern* block which shows the number 01010101.

that pulse. In other words, if the shortest pulse you expect to encounter is 50ns, choose a sample period that is less than 50ns.

Trigger and trace points

Another term that should be familiar to oscilloscope users is *triggering*. It also is used in logic analyzers, but in connection with another term, *trace point*. What is the difference between trigger and trace points? Well, the easiest way to explain is by saying that the trace point is where the analyzer actually starts to capture data. In some cases you may need to set and trigger and then tell the analyzer to delay capturing data for a certain period of time. For instance, you may want to capture data on the data bus after a WRITE instruction. Because the data may not be valid when the WRITE line goes low, you can delay, say 100ns after the WRITE pulse to make sure data you catch is valid. This is the trace point. In other words,

$$\text{Trigger} + \text{Delay} = \text{Trace Point} \\ (\text{See Figure 7})$$

Setting trace specifications on a timing analyzer is a bit different than setting trigger level and slope on an analog oscilloscope. Many analyzers trace on a pattern of

Now test and restore every CRT on the market . . . without ever buying another adaptor socket or coming up embarrassingly short in front of your customer . . . or your money back

highs and lows across input lines. Notice the trace menu in Figure 8. We have told the analyzer to start capturing data when channels 0, 2, 4 and 8 are high (logical 1) and when channels 1, 3, 5 and 7 are low (logical 0). Figure 9 shows the resulting display with the trace point indicated at the left of the screen by the heavy dotted line. At the trace point channels 0, 2, 4 and 8 are all high while channels 1, 3, 5 and 7 are low. In this case, the trigger and trace points are at the same place, because we haven't specified any delay.

To make things easier for some users, the trigger point on most analyzers can be set not only in binary (1's and 0's) but in hex, octal, or decimal. For instance, to set the previous example in hex, the trigger specification would be 55 instead of 0101 0101. Using hex for the trigger point is particularly helpful when looking at buses that are 4, 8, 16, 24 or 32 bits wide; imagine how cumbersome it would be to set a specification for a 24-bit bus in binary.

Edge triggering is a familiar concept to those accustomed to using an analog oscilloscope. When adjusting the trigger level knob on a scope, you could think of it as setting the level of a voltage comparator that tells the scope to trigger when the input voltage crosses that level. A timing analyzer works essentially the same on edge triggering except that the trigger level is preset to logic threshold. Why include edge triggering in a timing analyzer? While many logic devices are level-dependent, clock and control signals of these devices are often edge-sensitive. Edge triggering allows you to start capturing data as the device is clocked. As a simple example, take the case of an edge-triggered shift register that is not shifting data correctly. Is the problem with the data or the clock edge? In order to check the device, we need to verify the data



with the new improved CR70 "BEAM BUILDER"™
Universal CRT Tester and Restorer
Patented \$995

Have you ever?

Thrown away a good TV CRT, data display CRT, or scope CRT that could have been used for another two or three years because you had no way to test or restore it?

Lost valuable customers because you advised them that they needed a new CRT when another technician came along and restored the CRT for them?

Lost the profitable extra \$35 or more that you could have gotten for restoring a CRT while on the job and locked in the profitable CRT sale later?

Avoided handling profitable trade-ins or rentals because you were afraid you'd have to replace the picture tube when you could have restored it?

Had a real need to test a CRT on the job, but didn't have the right adaptor socket or setup information in your setup book?

If any of these things have happened to you, **CALL TODAY, WATS FREE, 1-800-843-3338**, for a **FREE 15 day Self Demo**.

"BEAM BUILDER" is a trademark of Sencore, Inc.



Call Today Wats Free 1-800-843-3338

SENCORE

3200 Sencore Drive
Sioux Falls, SD 57107
605-339-0100 In SD Only

*innovatively designed
with your time in mind.*

Circle (14) on Reply Card

October 1986 *Electronic Servicing & Technology* 45

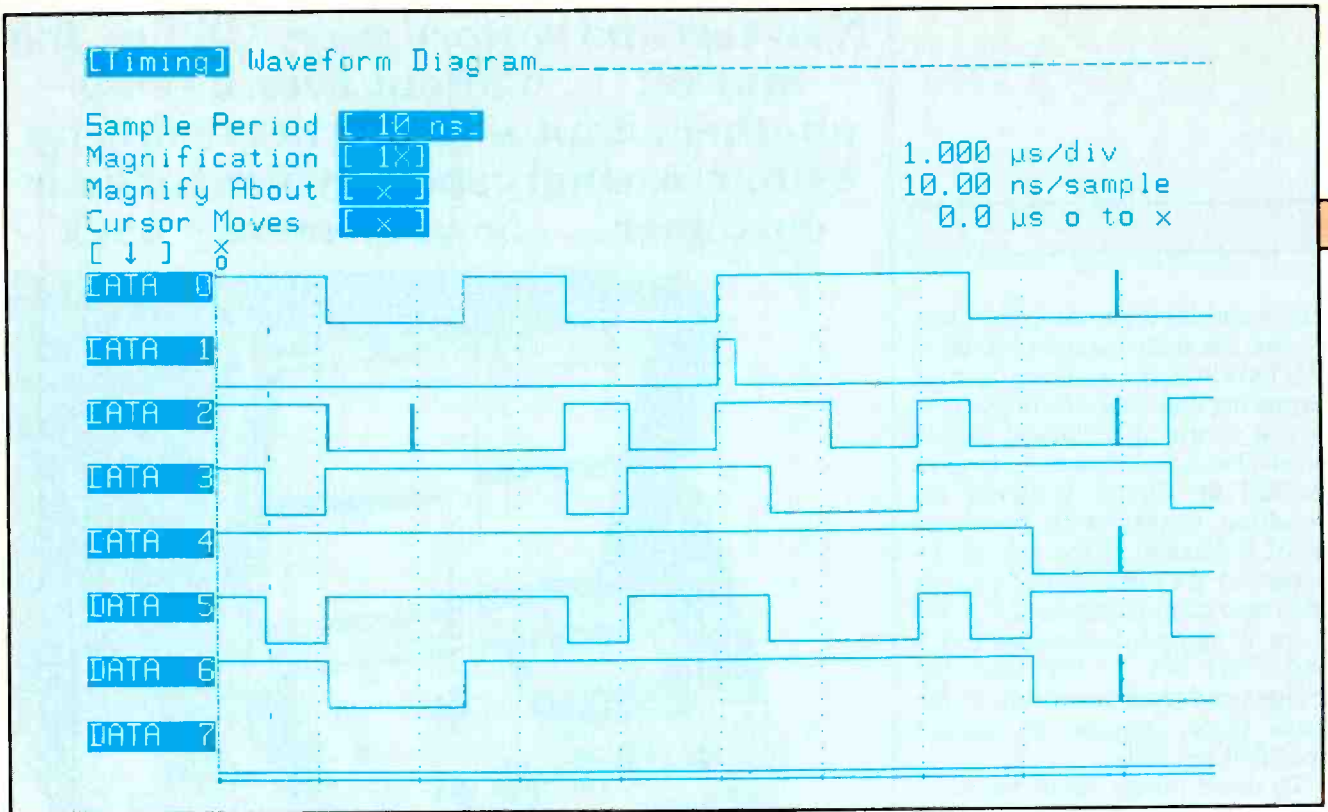

Figure 9. For one circuit being analyzed, the instructions shown on the logic analyzer screen in Figure 8 resulted in this waveform diagram.

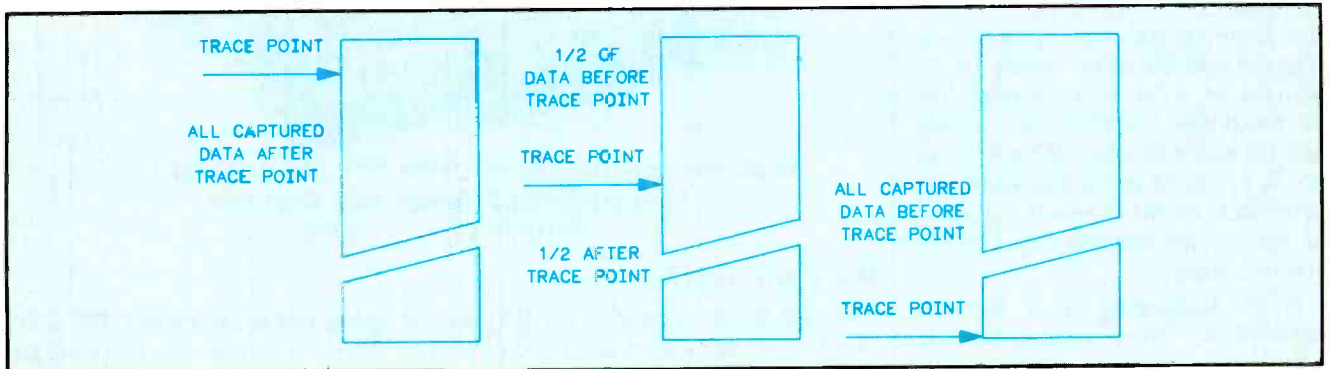

Figure 10. Because the logic analyzer stores data as it goes, it is possible to display data captured before the trigger point as well as data captured after the trigger point.

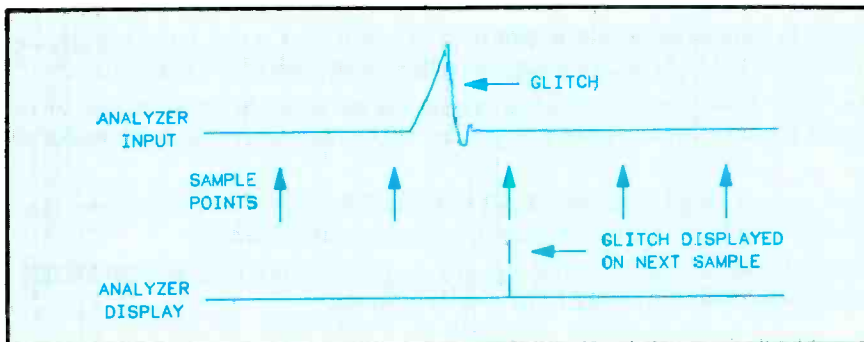

Figure 11. The ability to trigger on a glitch enables a logic analyzer to display data that occurred before the glitch. This can help to determine what caused the glitch.

when it is clocked—on the clock edge. The analyzer can be told to capture data when the clock edge occurs (rising or falling) and catch all of the outputs of the shift register. Of course, in this case, we would have to delay the trace point to take care of the propagation delay through the shift register.

Placing the trace point

Another useful capability of a timing analyzer is being able to specify when we store data with respect to the trigger point. Should the trigger point be the start of the data, in the middle of the data, or at the end? Figure 10 shows all three alternatives. Putting the trigger point at the start of the data is used most often and is appropriate when you want to

Walk "tough dog" troubles out of any TV & VCR in half the time . . . or your money back



with the exclusive, patented,
VA62 Universal Video Analyzer . . . \$3,295

Would you like to?

Reduce analyzing time: Isolate any problem to one stage in any TV or VCR in minutes, without breaking a circuit connection, using the tried and proven signal substitution method of troubleshooting?

Cut costly callbacks and increase customer referrals by completely performance testing TVs & VCRs before they leave your shop? Own the only analyzer that equips you to check all standard and cable channels with digital accuracy? Check complete, RF, IF, video and chroma response of any chassis in minutes without taking the back off the receiver or removing chassis plus set traps dynamically right on CRT too? Simplify alignment with exclusive multiburst pattern?

Reduce costly inventory from stocking yokes, flybacks, and other coils and transformers, for substitution only, with the patented Ringing Test. Run dynamic proof positive test on any yoke, flyback, and integrated high voltage transformer . . . in- or out-of-circuit?

Protect your future by servicing VCRs for your customers before they go to your competition? Walk out "tough dog" troubles in any VCR chrominance or luminance circuit — stage-by-stage — to isolate problems in minutes? Have proof positive test of the video record/play heads before you replace the entire mechanism?

Increase your business by meeting all TV and VCR manufacturers' requirements for profitable warranty service work with this one universally recommended analyzer?

To prove it to yourself, CALL TODAY, WATS FREE, 1-800-843-3338, for a FREE Self Demo . . . or learn how the VA62 works first by calling for your free simplified operation and application instruction guide, worth \$10.00.

look only at the data after the trigger. The example in the previous paragraph of checking a shift register is a good illustration. We know that the clock edge starts the data shift, and we are not interested in anything that happens before the clock. All the data of interest occurs after the clock edge.

Putting the trace point at the end of the data lets you see how you got to that point. You could think of it as a problem solving measurement, when you need to see all the things that led up to the problem.

Placing the trace point in the middle of the data gives you the best of both start and end trace. It provides data on both sides of the trace point, letting you look backward and forward in case there is some doubt as to where the fault actually may be.

Glitch capture

One headache of digital systems is the infamous *glitch*. They have a nasty habit of showing up at the most inopportune times with the most disastrous result. How do you capture a glitch that occurs once every 36 hours and sends your system into the weeds? Once again the timing analyzer comes to the rescue.

A glitch can be caused by capacitive coupling between traces, power supply ripples, high instantaneous current demands by several devices, or any number of other events. Because they are difficult for most oscilloscopes to differentiate from valid transitions, a scope is generally not helpful in tracking down a glitch. However, because a timing analyzer samples the incoming data and can keep track of any transitions that occur between samples, it can readily recognize a glitch. In the case of an analyzer, a glitch is defined as any transition that crosses logic threshold more than once between samples. The analyzer already keeps track of all single transitions that occur between samples, as we



Call Today Wats Free 1-800-843-3338

SENCORE

3200 Sencore Drive

Sioux Falls, SD 57107

605-339-0100 In SD Only

*innovatively designed
with your time in mind.*

Circle (15) on Reply Card

Figure 12. A state for a logic device such as this "D" flip-flop is a sample of a bus or line when it is valid.

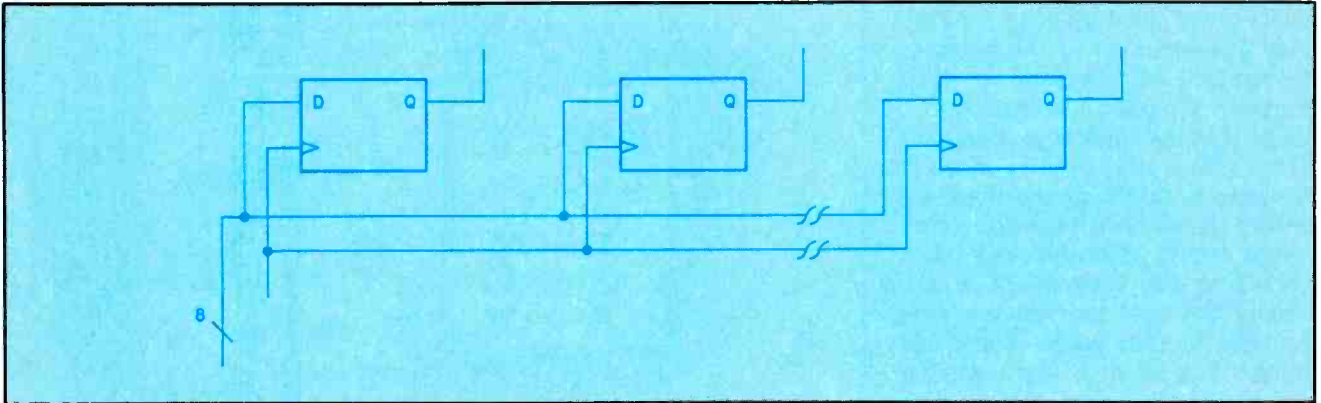
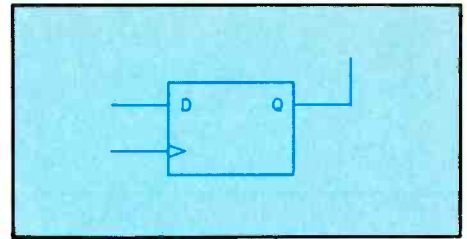

Figure 13. If you connect a state analyzer to these eight lines and tell it to collect data when there is a positive transition on the clock line, the analyzer will follow your directions.

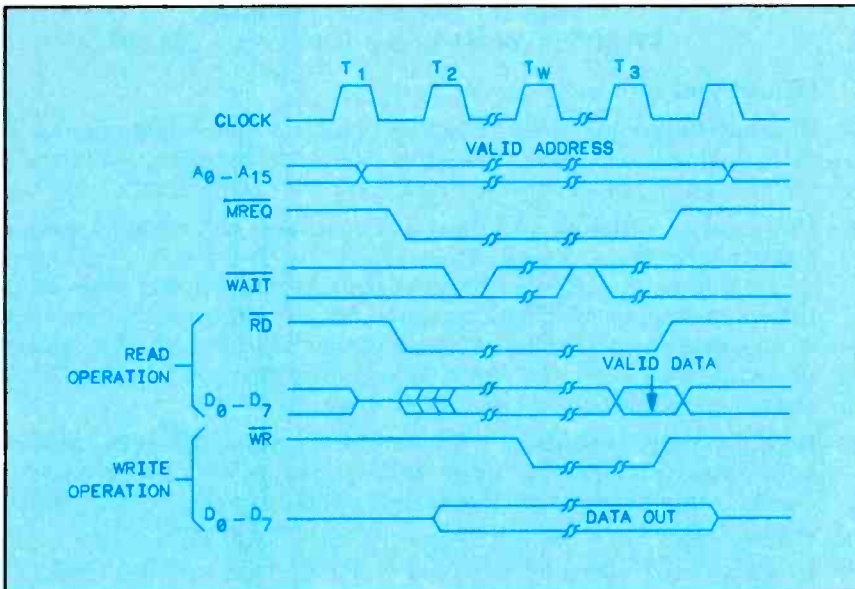

Figure 14. A microprocessor may have several clocks, and it is necessary to understand how they relate to one another in order to capture the data you need.

discussed before. To recognize a glitch, we *teach* the analyzer to keep track of all multiple transitions and display them as glitch(es) (See Figure 11).

Although displaying glitches is a useful capability, even more helpful is the ability to trigger-on a glitch and display data that occurred before it. This can help us to determine what caused it. This capability also enables the analyzer to capture data only when we want it: when the glitch occurred. Think about the example we mentioned in the beginning paragraph of this section. We have a system that crashes periodically because a glitch appears on one of

the lines. Because it occurs infrequently, to store data all the time (assuming we had enough storage capability) would result in an incredible amount of information to sort through. Another alternative is to use an analyzer without glitch trigger capability and sit in front of the machine pressing the RUN button and waiting until you see the glitch. Unfortunately, neither of the above is a practical alternative. If we can tell the analyzer to trigger-on a glitch, it can stop when it finds one, capturing all the data that happened before. We let the analyzer be the babysitter and when the system crashes, we have a record of everything leading up to the error.

What's a state analyzer?

If you've never used a state analyzer, you may think it's an incredibly complex instrument that would take a large time investment to master.

In the first part of this article, we considered one of two major parts of a logic analyzer: the timing analyzer. It is like a digitizing oscilloscope in some respects, especially when displaying timing waveforms. Because the horizontal axis on the waveform display is time, we say that it is in the time domain.

This section deals with the second major part of a logic analyzer: the state analyzer. A state

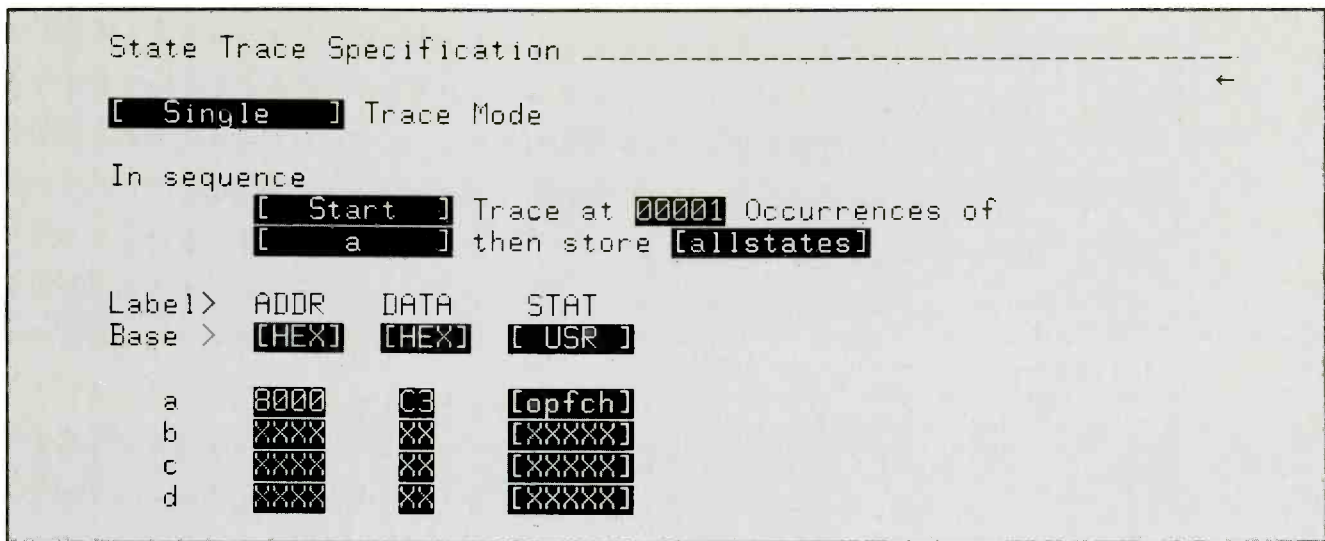

Figure 15. This analyzer display shows that the device was instructed to read the data from memory address 8000 (hexadecimal). It shows that the hexadecimal number C3 was found there.

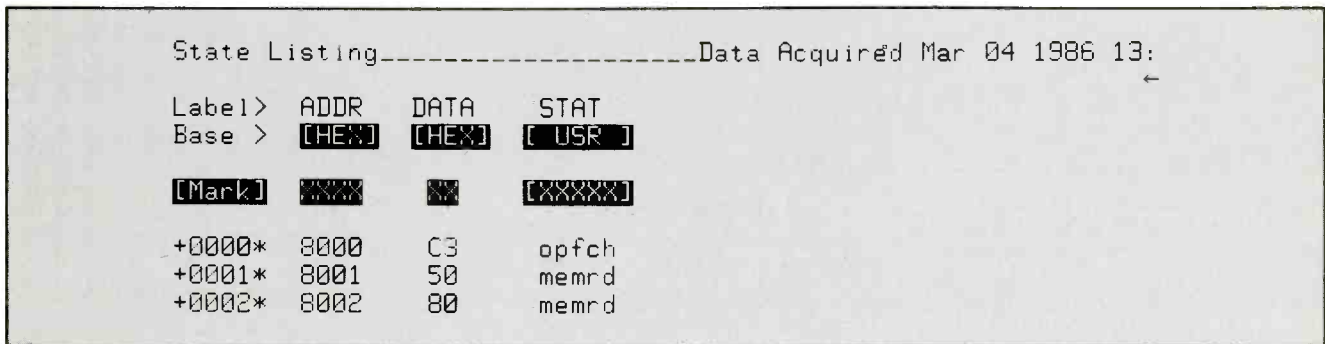

Figure 16. Here, the analyzer displays the data found in locations 8000 through 8002.

analyzer is used most often to trace the execution of instructions through a processor system. Each memory cycle's data, address, and status codes are captured and displayed as they occur on a microprocessor's buses.

What's a state?

If we are going to understand what a state analyzer does, we should know what a *state* is. A state for a logic circuit is a sample of a bus or line when it is valid (the state of the signal is sampled).

For example, take a simple "D" flip-flop, like the one in Figure 12. Data at the "D" input will not be valid until a positive-going clock edge comes along. Thus, a state for the flip-flop is when the clock edge occurs.

Now imagine that we have eight of these flip-flops in parallel (Figure 13). All eight are connected to the same signal as a clock. When a positive transition occurs on the clock line, all eight will capture data at their "D" inputs. Again, a state occurs each time they get a positive transition

on the clock line. These eight lines are analogous to a microprocessor bus.

If we connected a state analyzer to these eight lines and told it that a positive transition on the clock line is when we want to collect data, the analyzer would obey. Activity on the inputs will not be captured by the state analyzer unless the clock is going high.

This points up the major difference between a timing and state analyzer. The timing analyzer has an internal clock to control sampling, so it samples asynchronously to the system under test. A state analyzer samples synchronously to the system because it gets its sampling clock from the system.

Clocks

When the data is captured, a timing analyzer generally displays it in a waveform format, similar to what the actual digital circuitry sees. A state analyzer, on the other hand, generally displays data in a list format. Why? There is certainly nothing to keep the

data captured with a state analyzer from being displayed in a waveform (although you wouldn't be able to see the clock signal, because it isn't stored). And because a state analyzer is used mostly to trace instruction and data flow in a microprocessor system, a listing of all the states in hex, binary, octal or assembly language is more useful than waveforms.

In the timing analyzer, sampling is under direction of a single internal clock. That makes things very simple. However, in the world of microprocessors, a system may have several clocks.

Suppose for a moment that we want to trigger on a specific address in RAM and see what data is stored there. Further, we'll assume that the system uses a Zilog Z80. During a read-or-write cycle, the Z80 first puts an address on the address bus. Next it asserts MREQ, showing that the address is valid for a memory read or write. Last, the RD or WR line is asserted, depending on whether we are doing a read or write. The WR line is asserted only after the

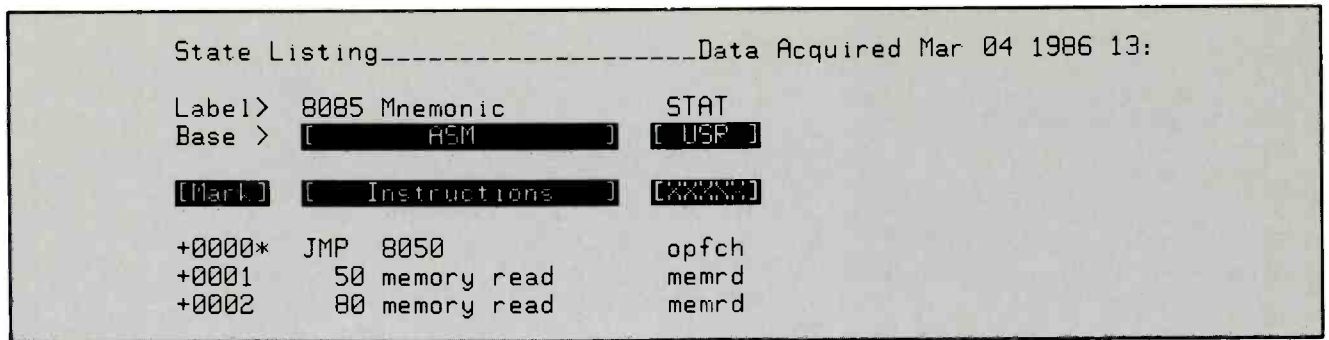

Figure 17. Most analyzers have an *inverse assembler* software package that translates hexadecimal instruction codes into a form of English understood by programmers, called *mnemonic* code.

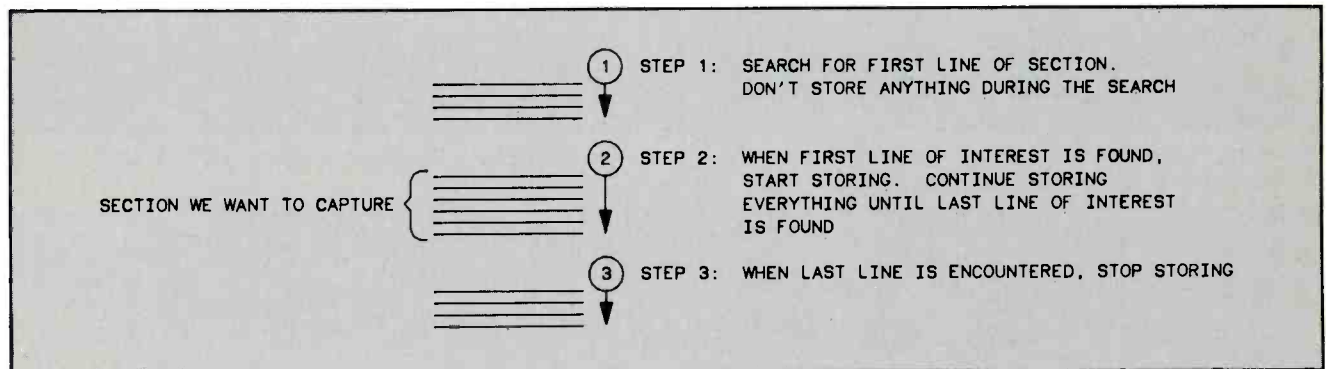

Figure 18. Analyzers are capable of selective storage, that is, storing only specific portions of an entire program (routines). This assists in troubleshooting areas where problems occur.

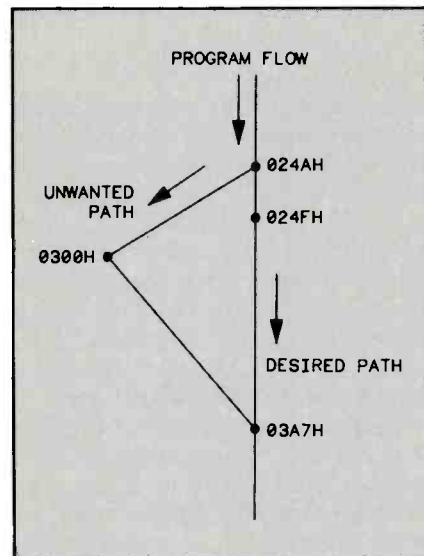

Figure 19. An analyzer allows the user to determine a desired sequence, and to ignore any sequences the user does not wish to examine.

data on the bus is presented as valid (see Figure 14).

In order to capture addresses from the Z80 with our state analyzer, we will want to capture when MREQ line goes low. But to capture data, we will want the analyzer to sample when the WR line goes low (write cycle) or when RD goes high (read cycle).

Demultiplexing

Some microprocessors multiplex data and address on the same lines. The analyzer must be able to clock in information from the same lines but with different clocks. This, in essence, acts as a demultiplexer to capture an address at the proper time and then catch data that occurs on the same lines.

Triggering

A state analyzer still gives the capability to qualify the data we want to store. If we are looking for a specific pattern of highs and lows on the address bus, we can tell the analyzer to start storing when it finds the pattern and continue storing until the analyzer's memory is full.

In the following example, (see Figure 15) we have set the trigger point as 8000H (hexadecimal). In this case we want to find out what is in location 8000H, so we set the data trigger as *don't cares* (xx). This tells the analyzer to trigger on address 8000H regardless of what the data is at that point.

The analyzer captured address 8000H and all following states. Notice that data is C3H at address 8000. Notice that all of the information is displayed in hexadecimal format. We could display it in binary, if that is helpful. However,

it may be more helpful to have the hex decoded into assembly code.

Disassembly

If you specify that all information on the buses is to be displayed in hex, you will get a display that resembles the one in Figure 16. What do these hex codes mean? In the case of a processor, specific hex characters comprise an instruction. If you are very familiar with the hex codes, you may be able to look at a hex listing like the above and know what instruction is represented by it. Most of us, however, can't do that. For that reason, most analyzer makers have designed software packages called disassemblers or inverse assemblers. The job of these packages is to translate the hex codes into assembly code to make them easier to read. For example, the display of Figure 16 has C3, 50, 80 and C3 shown. If you look up those codes in the 8085 manual, you find that they represent JMP 50 80 (jump to location 8050), and then another JMP instruction (C3). Rather than having to look each up, the inverse assembler does it for us. Look at the display of Figure 17 and notice the difference.

Sequence terms

State analyzers have *sequence terms* that aid in triggering. Se-

quence terms allow you to qualify data storage more accurately than a single trigger point. This means that you can window more accurately in on the data without storing information you don't need. Sequence terms usually look something like this:

```
find xxxxxx
then find xxxxxx
start on xxxxxx
```

Sequence terms are useful for getting into a subroutine from a specific point in the program.

Selective storage

Sequence terms make possible what we call *selective storage*. Selective storage simply means storing only a portion out of a larger whole. For instance, suppose we have an assembly routine that calculates the square of a given number. If the routine is not calculating the square correctly, we can tell the state analyzer to capture that routine. We do this by first telling the analyzer to find the start of the routine. When it does find the start address, we then tell it to look for the ending address while storing everything in between. When the end of the routine is found, we tell the analyzer to stop storing (store no states). Figure 18 shows how selective storage works.

Sequence restart

One additional feature of a state analyzer is something called the *sequence restart* item. Look at the diagram on the left. Let's say that the program could branch at address 024F depending on the value of a variable. You want the path to be from 024F directly to 03A7. Set the trigger sequence as

```
find 024A
then 024F
start on 03A7
```

The analyzer may go through address 0300, depending on the value of the variable (see Figure 19). Because you don't want that to happen, make sure that if 0300 is encountered along the way, the analyzer will ignore what it has and start over the next time through. The sequence restart term allows us to do exactly that. If we now set the trigger sequence to be

```
find 024A
then 024F
start on 03A7
sequence restart on 0300
```

the state analyzer will ignore any run that goes through address 0300. It will start storing only if it goes through the sequence without seeing 0300.

Summary

Most analyzers are made up of two major parts, timing and state. Together, they make up a powerful tool for troubleshooting digital

circuits.

The timing analyzer is closely akin to the oscilloscope, but is better suited to bus-type structures or applications where you are dealing with many lines. It also has the ability to trigger-on patterns among the lines, or even glitches.

A state analyzer is most often viewed as a software tool. In reality, it also has many uses in the hardware domain. Because it gets its clock from the system under test it can be used to catch data when the system sees it—on the system's clock.

ES&T

COMPUTERFACTS™

Dependable Computer Service Data

COMPUTERFACTS give technicians accurate, comprehensive, and dependable service documentation that is brand and model specific. Like Sams PHOTOFACT®, COMPUTERFACTS manuals contain schematics, tips, and hints to make repairs faster and easier.

Coverage now includes 18 computers, 10 computer systems, 20 printers, 9 disk drives and over 15 monitors including:

Monitors

Amdek™
Apple®
Commodore®
Hitachi®
IBM®
Panasonic®
Sanyo®
Zenith®



Printers

IBM®
NEC®
Okidata®
Star Delta
Star Gemini
TRS-80®

Disk Drives

IBM®
Rana Elite
Tandon®
TRS-80®
Zenith®

Computers

Franklin Ace™
IBM®
Osborne®
Sanyo®
Texas Instruments
Timex Sinclair
TRS-80®
Zenith®

COMPUTERFACTS contain:

CAD-Generated Schematics -- clear, readable schematics in Sams Standard Notation format.

GridTrace™ -- a "roadmap" to identify parts quickly and easily.

CircuiTrace® -- cross-referenced junctions and test points.

Quick-Check™ Guides -- pinpoint circuits and key components, referenced to actual board photos.

Easy-Read Waveforms -- show you exactly what test waveforms should look like.

Replacement Parts Cross Reference -- give you equivalent components to eliminate time-consuming trial and error.

SAMS

At \$19.95 for sets that cover individual components, or \$39.95 for self-contained computer systems, COMPUTERFACTS will pay for themselves with a single repair... and you pay much less than you would for manufacturer's data.

Because you can depend on the accuracy of COMPUTERFACTS, you can decrease the amount of time needed to make a repair and increase return business and referrals from customers appreciative of eliminated downtime.

For additional product information or to order, call toll-free... 1-800-428-SAMS and ask for operator 723; in Indiana call... 317-298-5566 or write to the address below.

Howard W. Sams ■ DM 723 ■ 4300 W. 62nd Street ■ Indianapolis, IN 46268

Circle (16) on Reply Card

Continued from page 22

calculation. The method is given in the operation manual.

Comments

All power for the LC-75 comes from the 120Vac line, so there are no batteries to test or replace. The power plug is the standard 3-prong type with the safety ground. Sencore advises users not to defeat the grounded third wire because excessive pickup of 60Hz hum can distort some of the readings (especially the weak ones) giving either a varying reading or an incorrect reading.

There is only one shielded input for the LC-75, and it comes from the test probes into a BNC connector and through a fuse holder with its 1A 3AG slow-blow fuse to the internal circuitry. Fuse removal and replacement is accomplished by unscrewing the BNC connector on the LC-75, as described in the operation manual page 12.

Do not use any test leads with the LC-75 except those supplied with the instrument. For transportation, the ac cable can be wound around formed plastic rods at the four rear corners (these function as feet when the unit is placed on its back) and the tilt handle can be moved to where it is convenient to use as a carrying bail.

In-circuit vs. out-of-circuit

Sencore LC-75 *Z-Meter II* is not intended for in-circuit capacitance or inductive tests. In some cases, the accuracy is degraded to an unacceptable degree. Other measurements can be made at some sacrifice of accuracy.

Capacitance measurements are the most critical, possibly because the circuit resistances operate to bleed the capacitor that is under test, thus preventing the RC-timing circuit from functioning. If the leakage is severe enough, no

reading can be obtained, just the overrange symbol.

Measurements of the actual inductances of coils or transformers are more tolerant of resistive loads, such as those found in circuit. Page 30 in the operation manual gives six ranges of inductance and the minimum resistive loads that will decrease the correct inductance reading by no more than 10%. In some cases, of course, a 10% accuracy is acceptable. Within these restrictions, the inductance test can be performed in circuit.

Sencore does not mention in-circuit testing of ESR. Of course, for accuracy, the capacitor requires removal from the equipment. However, my experience with servicing electronic problems produced by excessive ESR in electrolytic capacitors indicates that a precise reading often is unnecessary. For example, the very low resistance readings of the good capacitors are in marked contrast to the defective one and its reading of perhaps 30 Ω or 50 Ω . Technicians need to save all the bench time they can, and checking ESR in circuit is one way. Just be certain the receiver power is unplugged. If the method doesn't work for you, blame me, not Sencore, for they did *NOT* suggest it. After you believe an electrolytic has excessive ESR, remove it from the circuit for a more accurate test.

Ringings operate satisfactorily in circuit with many horizontal-deflection coils, yokes and flybacks. If you service many television chassis of the same number, I recommend you select one in good operating condition and ring the horizontal-driver transformer, the flyback and the yoke, writing down the ring numbers on the margin of the schematic. Next

time, you will know without question whether or not the conditions of the suspected components are good or bad.

In the operation manual, Sencore gives detailed instructions about removing the flyback loads one at a time (and allied tests) as a method of finding the prime source of a flyback that rings fewer than 10 times.

Miscellaneous comments

Supplied with each analyzer is a 47-page operation and maintenance manual, which has detailed information about the LC-75, about how to use it correctly, and how to refrain from using it.

LC-75 is the next generation from the original *Z Meter LC-53* that was released approximately in 1979. Incidentally, the LC-53 will continue to be manufactured and sold, according to Sencore, for those of you who have one and want a twin.

The *pull-out* drawer (under the machine and accessible from the front) was mentioned twice, but the contents were not described. Four charts show the maximum permissible limits for capacitor leakage and ESR. Drawings show how the equipment is connected for the various tests. In all, 12 pages (laminated over stiff paper) are furnished. After a technician has read and understood the operation manual, the pull-out information is sufficient for service calls or a refresher.

My own reaction to the LC-75 "*Z Meter II*" is this: I like it and have no suggestions about how it could be changed or improved. And if you detest the time-losing job of replacing questionable capacitors or flybacks as a method of testing, you will be enthusiastic about it too.

ES&T W

Literature

Ramsey Electronics has released its 1987 test gear catalog. The catalog is full of test equipment for the professional as well as the hobbyist. Some of the items featured are oscilloscopes, frequency counters, digital multimeters and the new Com 3 service monitor.

For the satellite television enthusiast, there is a section devoted to satellite TV components, from LNBs to receivers.

Circle (125) on Reply Card

This 26-page cross-reference guide, listing ECG remote control transmitters and the popular brand types they replace, is available from **Philips ECG**, an affiliate of **Amperex Electronic**, a North American Philips company.

The ECG line includes 71 types that are replacements for more than 170 original equipment transmitters.

Circle (126) on Reply Card

A pocket-sized brochure illustrated with color photographs, covering power protection devices for industrial applications, is available from **Sola**, a unit of **General Signal**.

The 16-page pamphlet focuses on hardwired units as well as portable plug-in units for micro/mini-computers, and augments product information with specification charts detailing the basic operating characteristics of Sola's products.

Circle (127) on Reply Card

Print Products International announces its Fall/Winter 1986 Sale catalog, containing tools and supplies for electronic maintenance and service. New lines featured are Leader test instruments, VIZ power supplies, Tripp Lite spike filters, AEMC meters, solid-state semiconductors and Sprague capacitors, as well as many brand-name tools and instruments for repairs in the field or depot.

Circle (128) on Reply Card

A brochure describing filters that suppress terrestrial interference in more than 400 satellite receivers is available from **Micro-wave Filter**.

The brochure focuses on three filter lines used to solve a majority of TI problems and contains a list of receivers and filters compatible with them. Even if a particular receiver is not listed, the enclosed analysis form may be completed and returned for a specific filter recommendation. There's information on how to identify interference, select and install filters.

Circle (129) on Reply Card

The **Eraser Company** has released an 8-page brochure describing its entire line of thermal wire strippers for removal of thermoplastic insulations on wires and cables used in the electrical and electronics industry.

Included is technical and applications information on both hand-held and bench type thermal strippers for stripping wires between 1 AWG and 43 AWG and cables of up to 1/2-inch OD. Most thermoplastic insulations, including Teflon, Kapton, PTFE, Tefzel, nylon and plastic, can be removed.

Circle (130) on Reply Card **ES&T**

PTS SLASHES MODULE PRICES UP TO 40%!

Your new PTS Product Guide has great news. PTS is cutting prices on popular modules by 10 to 40%!

Choose quality PTS replacement parts. You get automatic updates, full year limited warranty, and instock availability or fast 8-hour turnaround of all makes/ all models.

Plus you get real savings.

More professionals choose PTS

rebuilt modules than any other.

Put PTS to work for you.

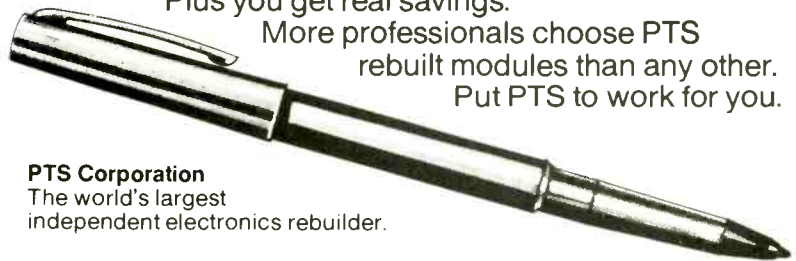

PTS Corporation
The world's largest
independent electronics rebuilder.

Send for your free Product
Guide today!

RCA		REPAIR		RCA		REPAIR	
MODULE #	PRICE	PRICE		MODULE #	PRICE	PRICE	
MAG001B	19.45	13.15		MCH001B	26.20	17.05	
MAH001B	21.10	14.35		MAE001B	19.20	12.85	
MDR001A	16.80	12.95		MDS001A	20.25	15.05	
MDG001A	21.30	15.35		MCS001A	21.30	14.50	
MAH004C	24.05	17.40		MDS001B	20.25	10.00	
MCH002B	26.20	17.05		MAC002B	21.10	12.00	
MDD001A	16.30	12.20		MDL002A	23.70	16.30	
MDC001A	24.10	17.85		MCL002A	25.35	18.35	
MAD001	16.65	11.00		MAG004A W	28.80	23.95	
	18.45	9.10		MAA001A	11.25	8.30	
				MST007	61.80	30.50	

Circle (17) on Reply Card

Test IBM PC's and XT's in Less Than 60 Seconds!



Introducing the Vu-Data AID/88 Low Cost Solution to PC Troubleshooting.

IBM® COMPATIBLE. Using the 8088 μ P, the AID/88 monitors the diagnostic instructions executed by IBM's own BIOS as it performs power-on self testing of the system board, reporting when the system halts and giving the reason.

STAND ALONE. The AID/88 verifies kernel integrity of the system board through complete built-in testing of the +5 volt supply, clock, address bus and data bus.

PRODUCTIVE & COST EFFECTIVE.

The AID/88 brings PC and XT system board maintenance "in-house" by extending repair capability beyond present IBM disk-based software. It pays for itself through reduced board float, and the delay and expense associated with "outside" repair.

USER READY & FRIENDLY. The AID/88 is pre-programmed with 10K bytes of software. Even an entry level technician is able to operate it guided by simple front panel instructions.

Start repairing PC's
for only
\$2995



9180 Brown Deer Road, San Diego, CA 92121
(619) 452-7670

IBM, IBM PC and IBM XT are registered trademarks of International Business Machine Corporation.

Circle (18) on Reply Card

What do you know about electronics?

Cable

By Sam Wilson

Technicians who are experts in electronics are sometimes complacent about such simple things as wire and coaxial cable. However, it is a good idea to review this subject from time to time so we don't lose touch with the technology.

In this article I have included a "Short course in the use of coaxial cables." It is programmed the same way that I program the review section of each chapter in my books.

A short course in the use of coaxial cables

Read the question in Block 1. If you believe choice (a) is correct go to Block 8 as directed. If you believe choice (b) is correct go to Block 12 as directed.

Continue to follow directions to the end of the course.

- The illustration in this block shows a transducer connected through a shielded twisted pair (called TWINAX), through a shielded amplifier, and to a galvanometer or recorder. Is this a proper installation)?
(a) Yes. Go to Block 8
(b) No. Go to Block 12
- The correct answer to the question in Block 6 is (b). A pulse can be thought of as being a fundamental frequency and a wide range of harmonic frequencies. If the system cannot pass the high-frequency harmonics the pulse shape will be altered.

Here is your next question:
Is this statement correct?

Use of coaxial cable assures that there will be no pickup of interference.

- (a) The statement is correct. Go to Block 20.
(b) The statement is not correct. Go to Block 5.

- Not correct. Read the question in Block 10 again, then go to Block 4.
- The correct answer to the question in Block 10 is (b). If you ground the shield at the points where it passes through the panels as shown in the illustration of Block 10, you are likely to introduce undesirable signals and/or noise in the load. This is because pickup signals can pass between the panels, through the coaxial braid. You have to be careful here because the coaxial connectors are frequently made in such a way that they ground the shield. So, you have to be careful when installing or replacing coaxial connectors. Make sure that you don't add a ground where a ground is not supposed to be. Only one point—at the signal source—should be grounded.

Here is your next question:

A two-conductor twisted balanced wire line with a specific impedance, and with a shielding braid around both wires, is called

- (a) triax cable. Go to Block 13.
(b) twinax cable. Go to Block 18.

5. The correct answer to the question in Block 2 is (b). Connecting circuits with coaxial cable will result in interference if the cable braid is not properly grounded.

Here is your next question:

A coaxial cable connector should be able to interconnect with a resistance of less than _____ milliohms. Go to Block 21.

6. The correct answer to the question in Block 18 is (a). The very great bandwidth of coaxial cable is surprising. It assumes the cable is properly installed.

Here is your next question:

A certain coaxial cable is to be used to deliver digital pulses at a maximum rate of 100 pulses per second (Pps). This should be treated as a (a) low-frequency installation. Go to Block 9.

(b) high-frequency installation. Go to Block 2.

7. The correct answer to the question in Block 11 is (a). As with any connecting conductor, the larger the diameter the lower the line loss.

Here is your next question:

You are going to connect two low-voltage circuits that are located three feet apart. You should use shielded cable (a) if the circuits operate only at low frequencies. Go to Block 19.

(b) if the circuits operate only at high frequencies. Go to Block 15.

(c) regardless of the frequency. Go to Block 10.

8. The correct answer to the question in Block 1 is (a). The installation is shown again in this block. Note that the shield of the cable is grounded *only at one point*—at the transducer end. That is essential in order to reduce noise and stray pickup.

Here is your next question:

Which of the following statements is correct?

(a) As long as you are using coaxial cables there will be no cross talk when they are bundled tightly. Go to Block 17.

(b) Tightly bundled coaxial cables can result in cross talk. Go to Block 11.

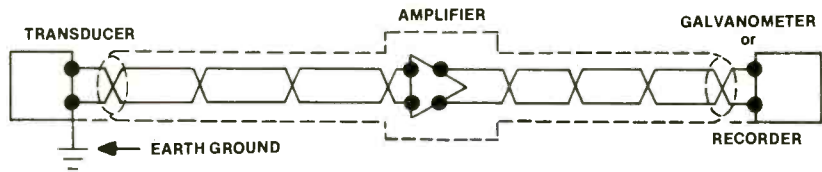

Figure 1.

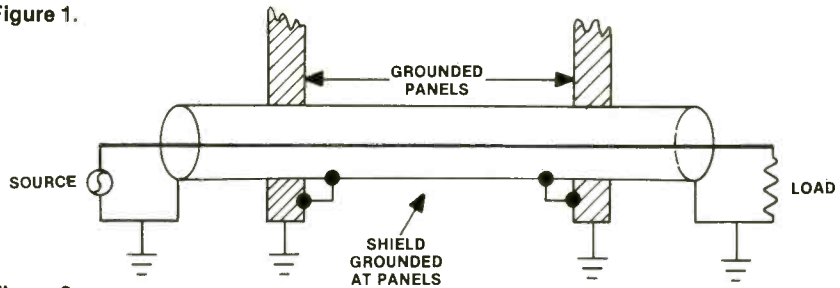

Figure 2.

CALL TOLL FREE

Include work address and phone number for Free Catalog.

800-824-2873

SCOPES

IWATSU



- All 14 models in stock
- 2-3 year warranties
- 20-250 MHz

MODEL	PRICE
5702	\$ 535
5705	\$ 899
5710	\$1245
5711	\$1695
5706	\$ 749

HITACHI V-222

Portable Dual Trace Scope

SALE \$535

LIST \$715⁰⁰



- DC-20 MHz
- 3-Way Power Supply
- Lightweight
- High Sensitivity and Fast Sweep Timer

HITACHI Hitachi Denshi America, Ltd.

- All 20 models in stock
- 2-3 year warranties
- 20-100 MHz

MODEL	PRICE
1050	\$1299
509	\$1199
VC6041	\$4400
422	\$ 690
1100	\$1900
650	\$ 930
V209	\$ 725
1070	\$1595
1100A	\$2490
V222	\$ 550

DIGITAL MULTIMETERS

BECKMAN

Beckman Industrial

- All 300, HD, and Circuitmate series
- All accessories in stock

MODEL	PRICE
HD100	\$169
HD110	\$189
HD130	\$239
HD140	\$259
300	\$120
310	\$145
320	\$179
330	\$219
350	\$229
360	\$289
4410	\$239

FLUKE FLUKE

- Autorange
- Touchhold function
- 0.3% accuracy
- Heavy duty Analog display

MODEL	PRICE	MODEL	PRICE
73	\$ 79	75	\$ 99
21	\$ 99	23	\$145
25	\$229	27	\$259
8010A	\$279	8012A	\$359
8020B	\$199	8022B	\$154
8024B	\$249	8050A	\$389

FLUKE 77

SALE

\$114

LIST \$139⁰⁰

Analog/Digital Multimeter



POWER SOURCES

POWER DESIGNS

- Low and high voltage power sources
- 1-5 year warranties

MODEL	PRICE
2020B	\$750
2K20	\$695
4050	\$660
6150	\$725
TW5005W	\$595
TW6050A	\$880
TW347	\$695
TP340	\$750
TP343A	\$795

USED TEST EQUIPMENT, TOO!—OVER 3,000 MODELS AVAILABLE AT HUGE DISCOUNTS WITH WARRANTIES!

■ Quantity Discounts Available ■ Dealers Welcome ■ Freight and Tax Extra ■ Immediate Availability of Equipment

US United States Instrument Rentals, Inc.

A U.S. Leasing Company
2988 Campus Drive
San Mateo, CA 94403

Circle (19) on Reply Card

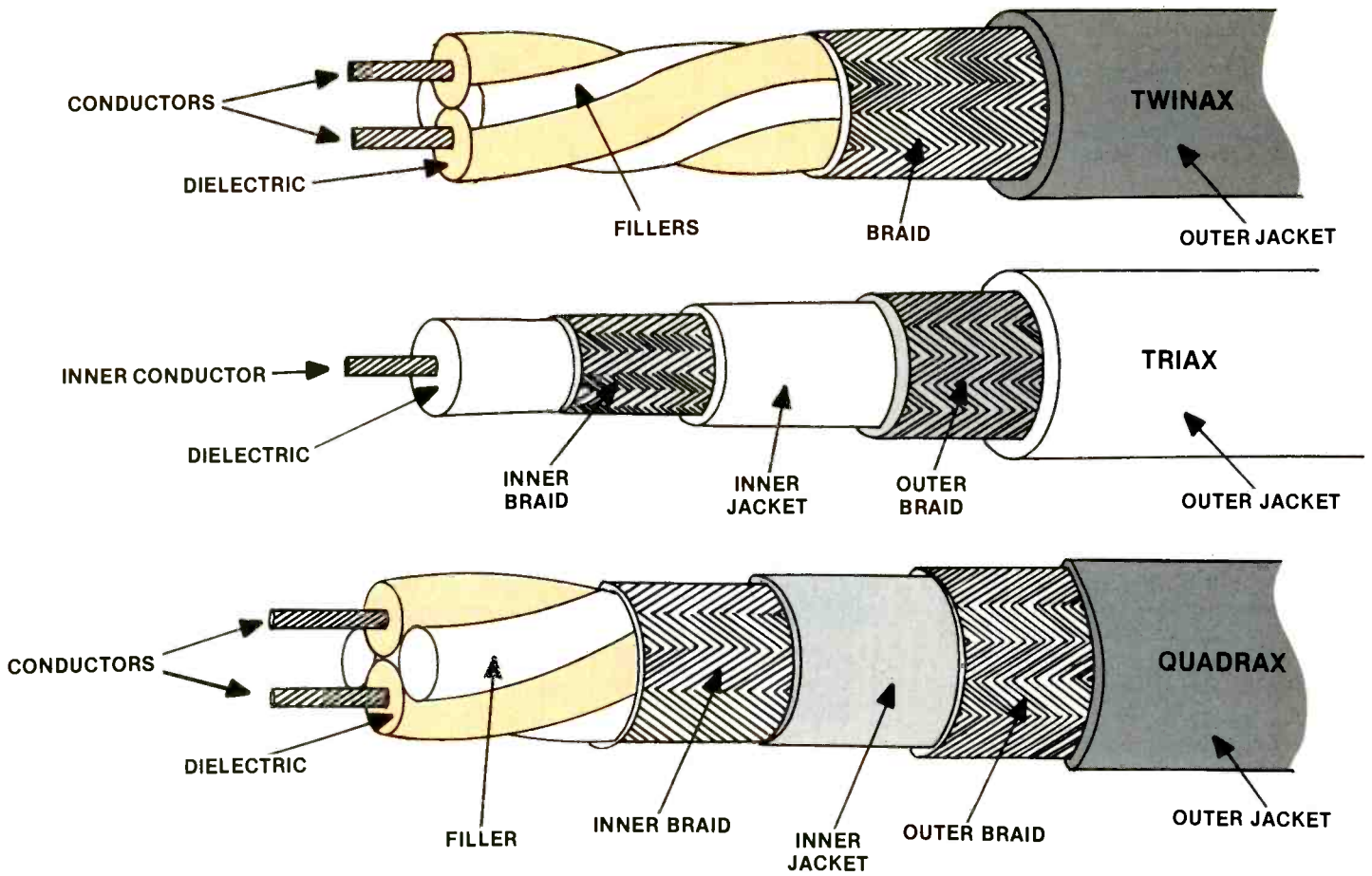

A.P.E.
 LEAD IN CIRCUIT ELECTRONIC TEST AND EQUIPMENT

FOR ALL YOUR:
 • SOLDERING/DESOLDERING
 • REPAIR/REWORK
 NEEDS ...

CALL FOR YOUR LOCAL A.P.E. DISTRIBUTOR:

AUTOMATED PRODUCTION EQUIPMENT CORPORATION
 142 Peconic Avenue • Medford, N.Y. 11763
 516-654-1197 • TWX: 510-228-2120

Circle (20) on Reply Card

HIGH VOLTAGE TRIPLERS/MULTIPLIERS

REPLACEMENT FOR **ECG®/GE®/SK®**

500A /GE527 & SK3304	8.75	6.95
523 /GE528 & SK3306	8.85	7.20
526A /SK3306	8.85	7.20
528 /SK3906	10.70	8.70
529 /GE529 & SK3307	9.99 3 MIN.	7.95 100 MIN.

OUTPUT TRANSISTORS

165 /SK3115 & GE38	2.25	1.95	1.75
238 /GE37 & SK3710	2.25	1.95	1.75
283 /SK3467	2.75	2.35	1.80
2SD1341P	2.25	1.95	1.75
2SC1172B	2.25 5 MIN.	1.95 50 MIN.	1.55 100 MIN.

AUDIO POWER

TYPE	10 min	50 min	100 min	TYPE	10 min	50 min	100 min	TYPE	10 min	50 min	100 min
152/SK3893	30	25	21	196/SK3054	49	44	39	291/SK3440	49	44	39
153/SK3274	30	25	21	197/SK3083	59	54	49	292/SK3441	49	45	40

RECTIFIER DIODES

	100	500	1000
125 1000V/2.5A	7¢	6¢	5¢
156 1000V/5A	18¢	16¢	13¢
506 DAMPER/HI-VOLT—FAST RECOVERY	29¢	24¢	19¢

\$\$\$ ADDITIONAL SAVINGS \$\$\$

TYPE	10 min	50 min	100 min	TYPE	10 min	50 min	100 min
102A	35	32	29	171	49	44	38
123A	18	16	14	184	38	33	28
123AP	13	11	09	185	38	33	28
128	38	35	29	198	60	54	49
129	38	35	29	199	18	15	12
130	59	55	49	234	19	16	13
159	16	13	11	375	44	42	39
162	2.25	1.95	1.49	712	75	69	60
163A	2.35	1.99	1.55				

FOR A COMPLETE LIST CALL OR WRITE—C.O.D. Orders Welcome (Min. Order \$25)

DIGITRON ELECTRONICS
 110 HILLSIDE AVENUE, SPRINGFIELD, NEW JERSEY 07081
 Toll Free 1-800-526-4928 In NJ 201-379-9016 Telex 138441
 PRICES SUBJECT TO CHANGE WITHOUT NOTICE. OFFER GOOD WHILE SUPPLY LASTS.
 ECG is a Trade Mark of Philips ECG, Digitron Ele. not associated with Philips ECG.

Circle (21) on Reply Card

9. Not correct! Read the question in Block 6 again, then go to Block 2.
10. The correct answer to the question in Block 7 is (c). A 3-foot connection in a low-voltage system SHOULD be made with a properly grounded coaxial cable. Remember that *low-voltage* circuits are most susceptible to stray pickup at all frequencies.

Here is your next question:

The coaxial installation in this Block is

- (a) properly grounded as it passes through the panels. Go to Block 3.
- (b) not properly grounded. Go to Block 4.
11. The correct answer to the question in Block 8 is (b). Don't assume that shielded coaxial cable is unable to pick up cross talk signals. Those signals CAN induce voltages in the shield and undesirable cross talk will be the result.

Here is your next question.

If you are comparing two

coaxial cables for a long run, use the cable with

- (a) the larger diameter. Go to Block 7.
- (b) the smaller diameter. Go to Block 16.
12. Not correct! Read the question in Block 1 again, then go to Block 8.
13. Not correct! Read the question in Block 4 again, then go to Block 18.
14. Not correct! Read the question in Block 18 again, then go to Block 6.
15. Not correct! Read the question in Block 7 again, then go to Block 10.
16. Not correct! Read the question in Block 11 again, then go to Block 7.
17. Not correct! Read the question in Block 8 again, then go to Block 11.
18. The correct answer to the question in Block 4 is (b). The illustration in this block compares TWINAX, TRIAX AND QUADRAX cables.

Here is your next question:

Properly grounded coaxial cable can be used to transmit signals in the

- (a) 20Hz to 5GHz range. Go to Block 6.
- (b) 100kHz to 500MHz range. Go to Block 14.
19. Not correct! Read the question in Block 7 again, then go to Block 10.
20. Not correct! Read the question in Block 2 again, then go to Block 5.
21. The correct answer to the question in Block 5 is 10 (milliohms). If the connector is crimped on it can be the cause of future trouble. The crimped connectors will increase in resistance as time goes by. Soldered connectors will last longer, but, they must be properly fabricated. You have to be careful that the heat doesn't degrade the insulation. Also, no cold solder joints are permitted!

You have now completed the programmed review of coaxial cable.

ES&T

The Quick Fix!

For Broken Floppies



Repair floppy drives without an oscilloscope. Only \$1395.

AVA
Instrumentation, Inc.

The Tester's Choice

8010 Highway 9, Ben Lomond, CA 95005 (408) 336-2281 Telex 5101007906 AVA

Is your time valuable?

Here's a new piece of test equipment that will help you repair floppy drives *fast!* Now perform radial, azimuth, Index to burst, Track 0, RPM tests and more, with single push-button ease. Much faster than an oscilloscope, the 803XP displays waveforms and numerical readouts, with the same accuracy, thanks to its onboard 8085 μ processor. Replace the oscilloscope and bench top clutter of other equipment with just one instrument, the AVA Model 803XP Alignment Scope. If your time is valuable, call now for a demonstration of this and other disk drive testers from AVA. ■

When it comes to microcomputers, there seem to be two diametrically opposed camps: those who have embraced them and want to know as much as they can about them, and those who can't stand the thought of computers and don't want anyone to even mention them.

For those who are fond of computers, the good news is that there is absolutely no end of books and magazine articles about computers. For those who hate computers, the bad news is that they are almost everywhere, and where they are not yet being used, they will be. That's why, yes, we're even going to have a monthly column on computers here in *Electronic Servicing & Technology*.

For those of you who maintain a strong hatred of computers, let me say I can sympathize. I, too, was a hater for a long time. For one thing, I had a bad experience while I was going through engineering school. I took a 1-semester course in FORTRAN programming and everything went wrong. First, I never quite understood the literal nature of computers, and although I thought that my program to calculate the integral of a function using Simpson's Rule was pretty reasonable, the computer thought otherwise.

When classmates finally convinced me of the error of my ways and I had produced a workable program, I had to stay up all night on a Saturday night to get time on the one computer in the school to run it. Even at that, the first time I got it punched in on paper tape, I found that I had torn the tape off too short and the reader could not read the "END" instruction, and I had to type it in again. As the sun began to light the sky, it came out correct.

That began a long hate period.

Later, whenever I encountered computers, they were cold, unfathomable beasts that demanded a specially controlled atmosphere and were always in brightly lighted, white, almost hospitallike rooms with air-handling systems that hummed menacingly and tried to lull me to sleep. And the people I dealt with who programmed and operated the computer spoke a jargon that left me on the outside. I was convinced that I would never have anything to do with computers if I could help it.

Now that I have been exposed to today's personal computers, I have an entirely different outlook. Today's computers are powerful tools, relatively inexpensive and fairly easy to use and to service if you invest a little time and effort. In fact, I, who am a pretty bad typist, am preparing this article using a word processor program that runs on my Commodore 64 computer, and if I'm careful, I can turn out absolutely perfect copy almost without effort.

A more compelling reason to become acquainted with microcomputers is that they are nothing more or less than very general purpose information processing devices, whose ability to evaluate information and make decisions is being taken advantage of in every kind of consumer electronic product. Take a look at microwave ovens, compact disc players, VCRs, digital radio receivers and TVs: You'll find computers in many of these products. If you plan to service these products, your life will be a lot easier if you're familiar with the operation of computers.

In fact, once you become acquainted with microcomputers you might find that working on the microcomputer portion of a product is easier than working on the other sections. With a TV set, for example, especially one that's direct-coupled as most are today (and with such enhancements as start-up and shutdown circuits) when a fault occurs, the troubleshooting procedure frequently includes such probing questions as: "Is the problem in this circuit that appears to be faulty, or is a circuit downstream

loading it down? Or is a circuit upstream not providing the correct voltage? Or is the start-up circuit not working? Or is the shutdown circuit working just as it should?"

The troubleshooting procedure in today's analog circuits is fraught with ambiguities. That is rarely the case with digital circuitry such as microcomputers. Once you have isolated a fault to the level of a particular circuit section, it ordinarily becomes a straightforward process of checking inputs and outputs. If a digital IC has the specified voltages at its power supply terminals, and the specified signal voltages at its signal inputs, but is not producing the specified output, it is almost certain that the IC is faulty. No ambiguity.

Take a look at the accompanying drawings. They illustrate the use of microcomputers in consumer electronic products. Microcomputers offer many advantages to circuit designers. As time goes by, there will be more and more use of computers in consumer electronic products.

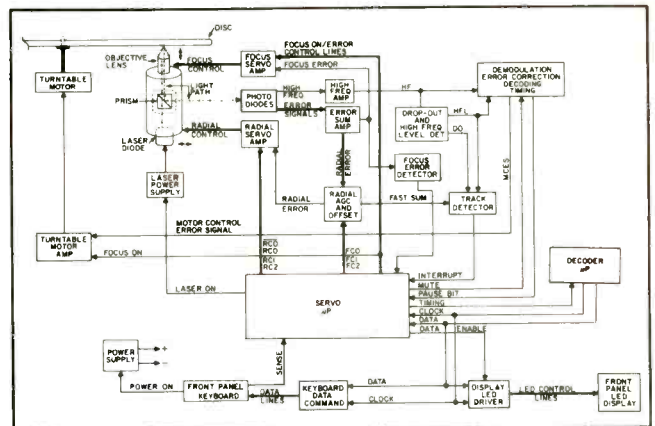

Figure 1. The NAP compact digital audio disc player shown in this block diagram features two microcomputers: one to control the motion of the laser stylus and one to handle the audio mute and pre-emphasis information.

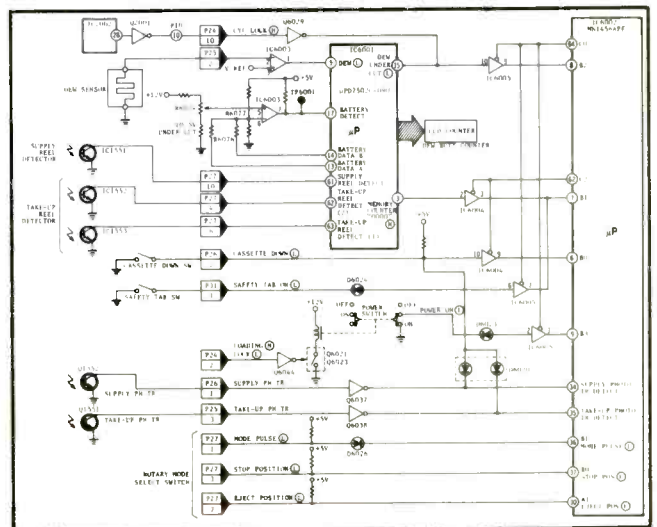

Figure 2. A modern consumer VCR contains circuitry to halt operation if conditions exist that could lead to damage to a videotape or to the VCR, itself. In the case of this GE VCR, two microprocessors operating in tandem perform this, and other, essential control functions.



ANSWERS to the QUIZ

By Sam Wilson

Questions are on page 24.

1. B. The adoption of the term *rms power* is offensive to anyone who understands the meaning of rms. Technically, there is no such thing as rms power.

2. B. Figure D shows the power wave along with the current and voltage. Note that there are two cycles of power for one cycle of voltage and current. This is to be expected. When the ac current flows through a resistor it is heated on each half cycle. So, it is heated twice for each cycle of current.

3. A. A PLE lookup table is an integrated circuit. PLE stands for programmable logic element. A lookup table is a PLE that has been programmed for a specific job, such as converting the radius value to the perimeter value.

4. A. The type of wire wrap shown is very difficult to unsolder and disconnect. Also, it is unnecessary for making a good solder connection.

5. B. Series-wound motors *must* be connected to a mechanical load.

6. B. The dummy load is used in place of the antenna. It permits the transmitter to be adjusted or repaired when it is delivering its rated power.

7. A. This is the definition of unity coupling.

8. A. The voltage is leading the current. That is the same as saying that the current is lagging. Note

that the angle is 90° , so the circuit is only inductive.

9. Both are symbols used for tunnel diodes.

10. The *data bus* carries information. The *address bus* carries the location from which the information goes or comes.

The *control bus* carries signals for operating various circuits inside and outside the microprocessor.

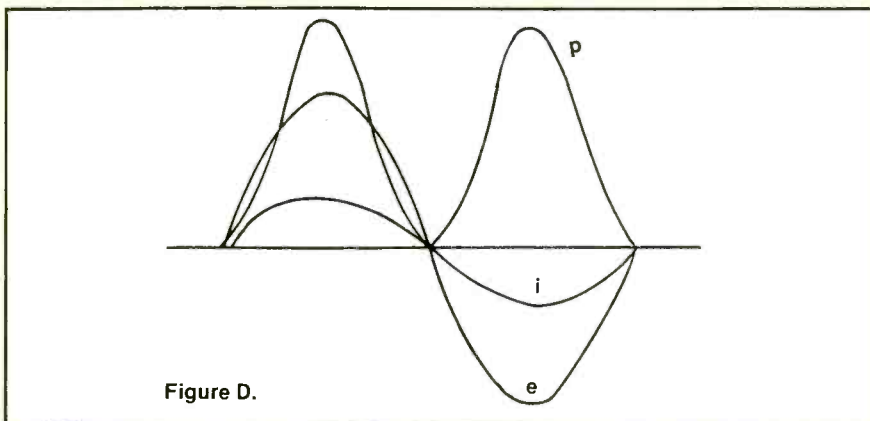

Figure D.

CONNECTION PROTECTION

SWITCHES & RELAYS

EDGE CONNECTORS

PLUGS & SOCKETS

POTENTIOMETERS



CONNECTING CABLES

TERMINAL STRIPS

GOLD PLATED CONNECTORS

BATTERY CONTACTS

CRAMOLIN®

Even the finest equipment in the world cannot guarantee noise-free operation. One "dirty" connection anywhere in the electrical path can cause unwanted noise or signal loss.

"MORE THAN A CONTACT CLEANER"

CRAMOLIN® is a fast-acting, anti-oxidizing lubricant that cleans and preserves all metal surfaces, including gold.

When applied to metal contacts and connectors, **CRAMOLIN®** removes resistive oxides as it forms a protective molecular layer that adheres to the metal surfaces and maintains maximum electrical conductivity.

CRAMOLIN® - USED BY THOSE WHO DEMAND THE BEST:

Bell & Howell

Hewlett Packard

MCI(Sony)

Nakamichi

Capitol Records

John Fluke Mfg.

Motorola

RCA

Dolby Laboratories

McIntosh Labs

NASA

Switchcraft

SINCE 1956

CAIG LABORATORIES INC.

1175-O Industrial Ave., (P.O. Box J) - Escondido, CA 92025-0051 U.S.A. • (619) 743-7143

Circle (24) on Reply Card

Durable Desoldering Tools

Sterling® Brand from Wahl Clipper Corporation

- High quality at a low price. You pay a little and get a lot.
- Anti-static or static-free desoldering tools available. End all worries about static electricity harming your components.
- Replaceable tips last twice as long as regular teflon tips (approximately 2,000 suction).
- Easy one-hand operation. Grooved handgrip and curved thumb-holder reduce fatigue during long desoldering operations.
- Self-cleaning. Plunger clears the tip of hardened solder. You'll always get a high-vacuum suction.

For more information on anti-static or static-free desoldering tools, or our full line of soldering irons, call or write.

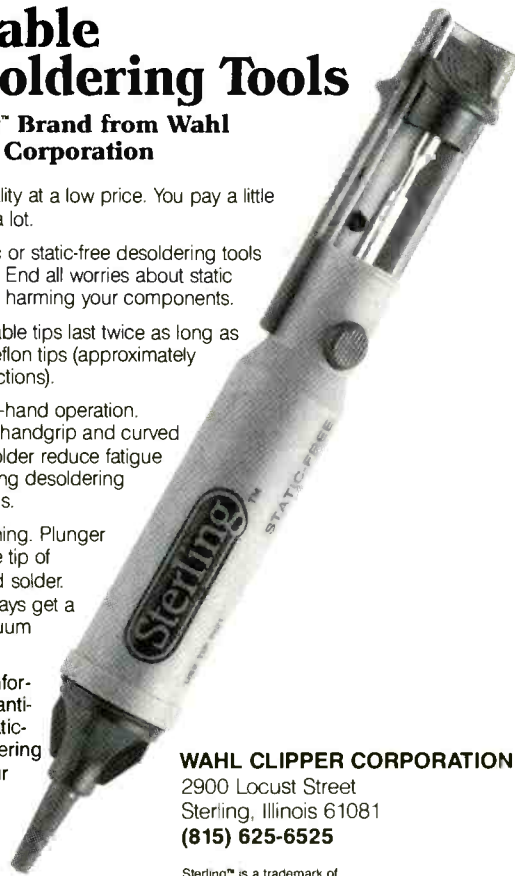

WAHL CLIPPER CORPORATION

2900 Locust Street
Sterling, Illinois 61081
(815) 625-6525

Sterling™ is a trademark of Wahl Clipper Corporation.

Circle (25) on Reply Card

Products

Miniature soldering iron

An industrial grade miniature soldering iron for precision electronic assembly and manufacturing operations is available from *M.M. Newman*.

The Antex Model G/3U miniature soldering iron features slide-on tips that are directly grounded to protect sensitive electronic components. The G/3U heats up to 725°F in only 45 seconds, and has available more than 40 different tip styles, including a .012 inch tapered needle point.

Lightweight and easy to handle, this miniature soldering iron has a 6½ inch long, non-charring plastic handle and weighs ¾ ounce. It is equipped with a 3-wire, 6-foot-long cord. The heating element is in the tip, therefore the handle always remains cool.

Circle (75) on Reply Card

DM-310 digital multimeter

Model DM-310 digital multimeter is part of the multimeters and accessories line recently announced by *Philips ECG*, an affiliate of *Amperex Electronic, North American Philips*.

The DM-310 has a 3½ digit LCD readout and a basic dc accuracy of ± 0.1%. The hand-held meter provides 29 ranges and separate continuity and diode tests. All ranges have overload protection, and the DM-310 has an auto-polarity feature to prevent it from being hooked up backwards.

One of five new multimeters in the line, model DM-310 is equipped with a 9V alkaline battery that provides 2,000 hours of operation. A low-battery indicator is displayed when battery life is reduced to 20%. The meter also is equipped with a tilt stand, spare fuse, test leads and instruction manual.

Circle (76) on Reply Card

Card size digital multimeter

Siber Hegner North America has added Teston's card size digital multimeter, Checkman Mini,

model DM1000, to its line of compact, 3½ digit, autoranging digital multimeters. This self-contained multimeter, in a protective vinyl case, with probes attached, folds to 4.5"x3"x0.5" and weighs only 3 ounces. It is designed to be carried at all times, and fits easily into a shirt pocket. The unit tests and measures ac/dc volts, ohms, continuity, and performs diode checks.

Featured are 0.7% basic dc accuracy and an easy-to-read LCD.

Circle (77) on Reply Card

Manual insulation strippers

A series of Wire-Wrap C-type insulation strippers has been announced by *The Cooper Group*. These manual strippers precision-strip 360° of insulation without nicking the conductor. They work on Teflon, Mil-ene and most other hard-to-strip insulation.

Available in wire sizes from 22 to 34 AWG, the strippers feature a strip-length guide in both inch and metric graduations. They are designed to fit comfortably in the hand, and have a smooth action.

Circle (78) on Reply Card

ES&T

FLUKE

70 Series Digital Multimeters

3½ digit multimeters combine a 3200 count LCD display with an analog bar graph for quick visual checks of continuity, peaking, nulling and trends. The unparalleled operating ease, instant autoranging and 2,000+ hour battery life make this a lot of meter for the price. 3 year warranty.

FLUKE 73
• 0.7% basic DC accuracy
• Autoranging only
Reg. \$79.00
SALE \$76.50

FLUKE 75
• 0.5% basic DC accuracy
• Autoranging
w/range hold • 10 amp + autoranged mA ranges • Continuity & diode • Test beeper
Reg. \$99.00
SALE \$89.00

FLUKE 77
• 0.3% basic DC accuracy
• Autoranging
w/range hold • 10 amp + autoranged mA ranges • Continuity & diode • Test beeper • Touch-Hold
Reg. \$139.00
SALE \$125.00

Send now for your **FREE** catalog of electronic tools & test equipment

w.s. **JENKS & Son**



1933 Montana Ave. NE
Washington DC 20002
(202) 529-6020

Call TOLL-FREE
1-800-638-6405

Circle (26) on Reply Card

PRB . . . OFFERS THE PROFITABLE SYSTEM FOR SELLING VIDEO RECORDER BELTS

The PRB stock number describes the required belt. You just size the belt on our handy MEASURE-A-BELT gauge and you'll have all the info needed to find your belt. The PRB System is fast, easy and profitable!

For details on our profitable belt system and the complete line of PRB electronic components just call toll free . . .

National 1-800-558-9572
Business Number 1-414-473-2151
In Wisconsin 1-800-242-9553
TLX 4994411 PRB USA
In Canada call collect: 1-613-225-5003

PRB
PROJECTOR RECORDER BELT
200 Clay Street, Whitewater, WI 53190

Circle (27) on Reply Card

SPECIAL

CW, CCW — 6V, 9V, 12V
5 FOR \$30.00

2SC 1308 or 2SD 1341
10 FOR \$19.90
2SD 870
10 FOR \$22.40



60-40 Solder
2 For \$18.00

ADC QLM30MK III
2 FOR \$12.00

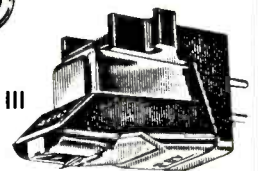

CALL US FOR 40 PAGE CATALOG

EPS 741 E. 14th St.,
Oakland, CA 94606
OUTSIDE CALIF.: 800-227-0104
IN CALIF.: 800-628-9664

Circle (30) on Reply Card

Photofact

These Photofact folders for TV receivers and other equipment have been released by Howard W. Sams & Co. since the last report in ES&T.

EMERSON

MTR1910 2434-1

GENERAL ELECTRIC

13BC5509XM01/N01, 13PF5510N01
(Ch. 13BC-M, 13BC-N) 2432-1

JC PENNEY

685-1520-00 2433-1

JC PENNEY

685-2217-00 2436-1

JC PENNEY

685-2094L-10 2437-2

MGA/MITSUBISHI

CS1942R/43R/44R 2435-1

MITSUBISHI

CS-1973R 2437-1

PANASONIC

CTF-1911, CTG-1911 2436-2

QUASAR

Chassis ALQDC110, ASDC110 2438-2

RCA

Chassis CTC131A/M 2433-2

SAMPO

K1342/S, K1354 (Ch. C6-13A) 2432-2

SEARS

564.40265450/6450/7550/7551 2434-2

TOSHIBA

Chassis TAC8511 2434-3

TOSHIBA

Chassis TAC8338 2435-2

TOSHIBA

Chassis TAC8501, TAC8506 2438-3

MONITOR

AMDEK

Color 300 2438-1

NIPPON AMERICA

COMBO CHAIN NOSE PLIER
N-20261 \$ 1.20

THREE WAY SPIKE PROTECTOR
P-511 \$ 2.50

VCR/TV SIGNAL SEPARATOR
N3-73 \$ 0.70

HONDA TYPE CAR ANTENNA
NP-2097 \$ 1.00
(Min. 3 Pcs.)

BATTERY TESTER 9V, 1.5V &
BUTTON BATTERIES
NBT-1 \$ 2.80

SEMICONDUCTORS
(Min. 5 Pcs.)

SG-613 .. \$6.50

CX-097 .. \$4.95

CX-885 .. \$8.70

TA-7246 .. \$1.65

TA-7323 .. \$0.75

TA-7607 .. \$1.70

TA-7617 .. \$2.15

(Min. 10 Pcs.)

2SC-458 .. \$0.05

2SC-461 .. \$0.04

2SC-606 .. \$0.25

2SC-930 .. \$0.08

2SC1061 .. \$0.36

2SC1162 .. \$0.25



FLYBACK TRANSFORMERS
Replacement for:
SANYO

F-0260 \$11.00

F-1119 \$15.50

F-1108 \$11.00

4-2751-4B500 \$ 7.50

4-2751-4B108 \$ 7.50

SHARP/SAMPO

8FT-043-B \$ 7.50

8FT-046 \$ 7.50

POPULAR FOCUS BLOCK
Replacement for:

SANYO/SEARS

Z20063UAA \$ 9.50

Z20064UAA \$ 9.50

Z20065UAA \$ 9.50

VIDEO TAPE REWINDER/VHS

MPS-550VH \$11.00

WET TYPE VIDEO HEAD CLEANING
CARTRIDGES

N-8780(VHS) \$ 2.85

N-8782(BETA) \$ 2.85

AUDIO TECHNICA PHONO CARTRIDGE

AT-70 \$ 5.50

AT-3482 \$ 4.95

ECONOMY VIDEO DUBBING KIT

VDK-1G \$ 2.25

VDK-2G \$ 3.95

COLORLED MICROPHONE CABLE

MC-1 (300 Ft. Spools)

Yellow/Blue/Red. \$18.00

OMNIDIRECTIONAL MIC. FOR
CASSETTE TAPE RECORDERS

DM-24 \$ 1.39

DC MICRO MOTOR

EC-9 \$ 2.00

DIGITAL TYPE MULTITESTER

Model: 7305 \$27.50

ELECTRIC FEEDING SOLDERING IRON

EF-6 \$10.00



the most important
"service manual"
any dealer could have...

the NASD
Catalog of
Member
Services...

dozens of proven
programs and
services to
increase
your profits!

Mail to: **NASD** Suite 310, 10 E. 22nd St., Lombard, IL 60148
or call David Ashton, Managing Director, at 312/953-8950

Please rush me a free copy of the Catalog of Member Services and
full details on how NASD membership can improve my business.

Name _____
Firm _____
Address _____
City _____ State _____ Zip _____
Phone _____

Circle (23) on Reply Card

October 1986 *Electronic Servicing & Technology* 61

9600 N.W. 12 St. Miami, Fl. 33172
TEL: 1-800-327-7522
LOCAL: (305) 592-2616 592-2618
Circle (28) on Reply Card
CALL OR WRITE C.O.D. ORDERS WELCOME (Min. Order \$25)

The terms *revolutionary*, *quantum leap*, *technological triumph*, have been so abused by Madison Avenue that I'm reluctant to use them in this column. But what else can you say about a medium that provides a 96dB signal-to-noise ratio, flat frequency response across the audio range, is immune to wear, and has no flutter or wow? What superlatives can express the joy of a music lover when he discovers that he's able to sit through an entire symphony without getting up to turn over the record? Of course, we're talking about the compact disc, or CD.

The CD made its debut several years back, in a market suffering from debilitating ennui, brought about by a weak economy and lackluster improvements in audio technology. Sure we were seeing more computer-controlled equipment, more sophisticated displays and flashing LEDs, but none of these things could overcome the annoying ticks and pops we heard when listening to the best signal source available, the LP phonograph record. The science of audio reproduction had reached a point where the source material was now the limiting factor in quality. We desperately needed something better to test the mettle of our low noise, low distortion amplifiers and receivers.

The compact disc was the brainchild of the Dutch electronics giant, Philips.

The compact disc was the brainchild of the Dutch electronics giant, Philips. The laser pickup system had been previously developed for the videodisc, and was adapted to audio with little modification. The major change was the substitution of a semiconductor laser for the bulky gas version. Not only did this cut the size of a player, it also cut the cost. For an overview of how a laser pickup works, refer to *Electronic Servicing*, September 1981, page 6.

Of course, the information recorded on a videodisc was analog, not digital. By the early '80s, large scale integration had reached a point where digital audio processing was possible with a comparatively small number of ICs. The time was right for the CD.

The compact disc itself is 120mm (4.75 inches) in diameter, recorded on one side only, and can accommodate approximately 550Mbytes of information. That's the equivalent of around 1,600 double-sided IBM formatted floppy disks. Maximum playing time is 74 minutes, although the longest disc you're likely to find is an hour. The information-bearing tracks are roughly 0.5 microns (0.005mm) wide, spaced 1.6 microns apart. A strand of hair, by comparison, is about 40 tracks wide. The actual program area, although only 33mm wide, can contain as many as 20,000 tracks. The astute technician probably is thinking we're going to need one heck of a precise servo system to make this thing work. Right! More about that later.

Just to keep things interesting for servicers, a microprocessor or two are usually thrown in for mechanism and user control.

Unlike a phonograph drive system, which is designed to turn the platter at a constant speed, the disc motor of a CD player varies from a maximum of 480 rpm when the pick is in the center to 240 rpm at the outside of a disc. Constant linear velocity (CLV) is what we're after. We want the bit stream (data) from the disc to be fed into the player at a constant rate. As the pickup tracks from the inside out (opposite to what we're used to with conventional phonographs), it covers more linear distance per rotation because the circumference of the track increases. Unless we slowed the motor down proportionally, the rate at which data came off the disc would increase, wreaking havoc with the precise timing circuits in the player. This concept will be familiar to those of you who've serviced laser video-disc players.

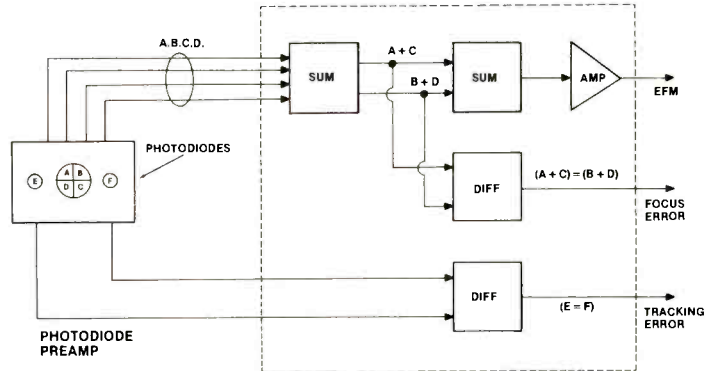

Figure 1. Photodiode signal processing

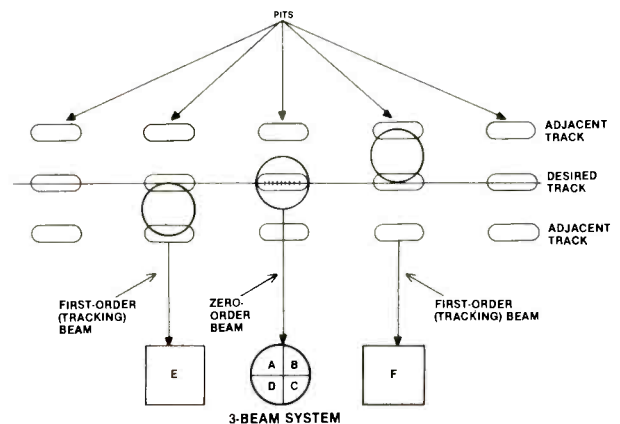

Figure 2. CD tracking system

The information is encoded on the disc as a series of pits and bumps in a reflective metallized coating that is bonded to the plastic disc. A layer of clear plastic 30 microns thick is laminated onto the information layer to protect it. Remember that a CD is read from the *bottom*—the side opposite the label. The pits and bumps amplitude modulate the laser light that is reflected into the pickup assembly. This is the data from which tracking information and program material is derived.

The signals from the disk are processed through three different circuits, to extract the EFM (music), TE (tracking error), and FE (focus error) data. The optical pickup is typically divided into six photodetectors. A, B, C, D are the main spot detectors. E and F are the sidespot, or *tracking* detectors. The EFM signal is equal to $A+B+C+D$. To generate a focus error, we use $FE = (A+C) - (B+D)$. You will notice that FE will be zero whenever the terms within the parentheses are equal. This will only happen when the light impinging upon the pickup forms a circular pattern, i.e., it is focused. When irregularities in the disc surface and drive system tend to change the distance between the lens and the information layer, the spot becomes oval-shaped. This produces a focus error, driving a coil that moves the objective lens on its vertical axis until correct focus occurs.

The E and F photodiodes are aimed at the tracks to either side of the current information track. Ideally, they will receive equal amounts of light when the pickup is centered. Since $TE = E - F$, the result will be zero under these conditions. Any variation indicates mistracking, which is corrected by a coil that moves the lens laterally. When the lens has moved to its limit, the sled motor takes over momentarily, moving the entire optical assembly in the direction of play. The sled takes care of coarse tracking, while the lens handles fine tracking.

We need yet another servo to keep the disc motor locked to the incoming data stream. Several methods exist, but the most common is to use a PLL (phase-locked loop) to synchronize a VCO (voltage-controlled oscillator) to the incoming EFM. We use a divider to generate a write-frame clock from the VCO, which is then compared to a reference clock (sometimes called a read-frame clock). A phase comparator combines these two signals to produce the correction voltage for the disc motor servo.

We're almost out of space, so let's summarize. The CD player uses a laser system to read digitally encoded data from a plastic disc that has roughly a one hour playing time and better overall performance than any analog medium. In order to do this, it utilizes several servo circuits that control focus, tracking, and disc motor drives. Just to keep things interesting for servicers, a microprocessor or two are usually thrown in for mechanism and user control. More on that in the future.

ES&T



Serving you the highest quality at very affordable prices

Our credentials are impeccable — friendly service, superb quality, affordable prices and quick delivery.

All of these things can be found in our latest catalog. And we've reserved a copy especially for you. To receive yours, simply call TOLL-FREE.

1-800-543-4330

In Ohio 1-800-762-4315

In Hawaii or Alaska

1-800-858-1849



858 E. Congress Park Drive • Centerville, Oh. 45459



MCM ELECTRONICS

A PREMIER Company

Source No. ES-14

Circle (29) on Reply Card

Readers' Exchange

Wanted: New, rebuilt or good used 310EUB4; 19DZP4 (BV or DV); 17LP4 or VP4. **For Sale:** Sams "Know Your Oscilloscope," new 21742, 4th edition, RSM \$6 money order, postpaid. *William Meyers, 508 19th St., Altoona, PA 16602.*

For Sale: Sams Photofact CB Radio series No. 2-11, 13-53, 55-139, 141-147, all for \$300 plus shipping. *Leonard Masi, 8853 Oliver Court No. 1, Manassas, VA 22110; 703-361-9025 or 703-361-4501.*

Wanted: Any or all possible information about Treasure Hawk mineral detector, model 0990, serial No. DA24580 (also need source for parts and circuit diagram); and about Universal tube tester, battery tester and ohmmeter, model 502, serial No. 3148, ac-powered set (need diagram, operating instructions and up-to-date tube setup chart). Will pay expenses. *Edward C. Day, RFD No. 2, Box 184, Ox Brook Road, Claremont, NH 03743; 603-542-9080.*

For Sale: Diehl Engineering Mark V in excellent condition, \$650. *608-238-4629.*

For Sale: Sams Photofact folders No. 1-2242, plus 45 assorted AR, TSM, CB manuals, with seven 4-drawer file cabinets, \$2,300 for all; B&K 415 sweep marker generator with manual, leads, \$200; B&K 1076 TV analyst, \$75; B&K E310B sine/square wave generator, \$100; Sencore SM152 sweep marker generator, \$75. All prices plus shipping. *Kenn Burkhart, 14533 State Route 127, New Weston, OH 45348.*

For Sale: Knight 5-inch, wideband oscilloscope with curve tracer accessory and manual, good condition, \$65; Sencore CG126 color-bar generator, good condition, \$55. Shipping and c.o.d. charges extra. *Ronald Kolasa, 4942 E. Flower Ave., Mesa, AZ 85206.*

Wanted: Back issues of **ELECTRONIC SERVICING & TECHNOLOGY**—1985 and January, February 1986. State price. *Glennon Swoboda, 402 East Brook, O'Fallon, MO 63366.*

Wanted: Diagram for Supermite battery charger, 6V and 12V, 8A, model 6124. Made in Chicago about 18 years ago by Barfield and Company. *Alfred E. Onsen, 8434 Sandusky, Kansas City, KS 66112; 913-299-0076.*

Needed: Schematic for Tappco 6-channel mixer and pre-amp, with reverber model 6000R. Will pay for copies. *Arthur R. Vickery, P.O. Box 742, Torrington, CT 06790.*

For Sale: Sams Photofact folders No. 67 to No. 625 plus 33 others, \$400 plus shipping. *Lyle D. Kinney, R.D. No. 4, Box 285, Bath, NY 14810; 607-776-9234.*

For Sale: Twenty-nine original Telefunken service manuals covering 1963-1969 radios, record changers and reel-to-reel recorder, all in excellent condition, \$100 for entire set. Send s.a.s.e. for list. *Gerald L. Moore, 1 Gladesworth Drive, Greenville, SC 29615; 803-268-0670.*

For Sale: Test equipment, B&K—1076 analyst, 415 marker generator, 510 transistor tester, 1465 scope, 1040 power supply, 1040 CB Service Master, 2040 CB signal generator, 1820 frequency counter, 1801 frequency counter, 465 CRT tester, 607 tube tester. Other test equipment by Sencore, EICO and Sprague, and Sylvania jig, model CK1500CX. Send s.a.s.e. or call for list. *Johnnie L. Hoggatt, Hoggatt Home Appliance, 617-19 Archer, Marshall, IL; 217-326-5122, days; 217-826-5889, evenings.*

Wanted: Panasonic color picture tube, model A-26JAS31X; Sams TSM servicing manuals; B&K CRT tester, model 470, adaptor sockets CR12 to CR29. *Ed Herbert, 410 N. Third, Minersville, PA 17954.*

Needed: Capstan motor and service manual, DoKorder 7700; service manual, Akai GX-1900D and Akai M-8. Will buy or copy and return. *Audio Service Company, 11 Grove St., Asheville, NC 28801; 704-253-3601.*

Wanted: Conar model 680 color generator, Conar model 200 appliance tester and Conar Custom-80 12-inch television. *William P. Jarvis, 1214 Fifth Ave., Beaver Falls, PA 15010; 412-846-7735.*

For Sale: Tubes, 1,000, priced at 85% off list; text books, service manuals, test equipment, radio and TV parts, magazines. Send large s.a.s.e. for list. *M. Seligsohn, 1455-55th St., Brooklyn, NY 11219.*

Wanted: Address of source for service literature for Dryco 8-transistor, 2-band radio, model T-806, made in Korea. If you have this literature, I will buy or copy and return, or I will reimburse the expenses. *Steve's Radio Service, P.O. Box 168, Wickes, AR 71973.*

Portable Variac® AUTOTRANSFORMERS & VOLTAGE REGULATORS Does The Job Right!



Advanced design and "hi-rel" performance make Variac portables the logical choice. Each portable Autotransformer is fully enclosed, has overload protection and generates output from 0 to 117% above line, efficiently. With Voltmeter, Wattmeter or Ammeter, you can choose from 2 or 3 wire versions in 120V, 5 to 18A models and in 240V, 2 to 8A units. The portable Voltage Regulators have

1KVA capacity and 115V ratings with custom units also available. Want smooth, fast response without distortion? Specify Variac to do the job right. Send for details.

You'll Think They're Custom Built!
TECHNIPOWER®
A **Denril** COMPANY
P.O. Box 222, Commerce Park, Danbury, Conn. 06810
Tel: (203) 748-7001 TWX: 710-456-9280

Circle (39) on Reply Card

Take the Guesswork Out of VCR Service

Tentel now has 3 products for quickly and easily diagnosing the mechanical performance of VCR's. **The Tentelometer®**



tape tension gauge is the world standard for tape tension measurements to prevent skewing and interchange problems. The TSH gauge series finds problems causing edge damage and binding cassettes, the two biggest causes of tape destruction. The New HPG-1 head protrusion gauge represents a breakthrough for an accurate, easy to use method of determining head life; takes the guesswork out of video head replacement. The HPG-1 for Beta, VHS, and U-matic VCR's measures head tip protrusion and drum eccentricity in both microns and ten thousandths of an inch.

These 3 products allow the entire mechanical performance of a VCR to be measured in a few minutes by only removing the top cover of the VCR.

Call or write for details—We want to help.

TENTEL (408) 379-1881
1506 Dell Avenue 800/538-8894
Campbell CA 95008 Telex 910 590 8001

Circle (31) on Reply Card

For Sale: Diehl Mark V, \$400; Diehl Mark III, \$200. Neither unit used, still in box, and with warranty and instruction manuals. *Roy Morgan, 102 Perth, Victoria, TX 77904.*

For Sale: Tubes—send your needs and I will quote. Try me for old and rare tubes. *Ted Youngman, 2225 Vigo St., Lake Station, IN 46405.*

Wanted: Will buy book or booklet "How to Turn Your TV into a TV Jig." *Pedro S. Martinez, P.O. Box 20972, Phoenix, AZ 85036.*

Wanted: Inside circuit diagrams of chips, ICs, plus...no pig-in-the-poke deals. *James Namish, 292 U.S. Highway 1, Monmouth Junction, NY 08852.*

Wanted: Bandpass filter for Toshiba model C924, chassis TAC7710, part No. 23260009. New or used, OK. *Ken Brown, Moore-Norman AVTS, 4701 N.W. 12th Ave., Norman, OK 73069.*

For Sale: Sams Photofact folders, \$1 each below No. 1500; \$2 each above. Quantity discounts. Other parts, equipment, etc., for sale. *Thacker TV, 5200 Wilson Blvd. Arlington, VA 22205; 703-528-7925.*

Wanted: Philco test equipment—077 RF signal generator and 022 oscilloscope. *Doug Heimstead, 1349 Hillcrest Drive, Fridley, MN 55432.*

For Sale: B&K 1077B TV analyst, like new, in original box, \$300; nine each of CRT adapters for B&K 467/470, CR12 to CR20, \$75. **Wanted:** Schematic and/or servicing procedure for Wometco home-theater decoder, model W4360. Also, has anyone put together a Simple Simon 7+11 PWD kit and made it work? Will appreciate any information on adjustments. *Mike Morales, 1470 Jefferson Ave., Brooklyn, NY 11237; 718-386-9719.*

For Sale: Sencore VA62 and VC63 with two high-voltage probes and all standard accessories, mint condition, asking \$2,200, post paid, or best offer. *Call 409-244-4614, 5 p.m. to 8 p.m., ask for Cornell.*

Wanted: Schematic diagrams for North American Video 9009V 9-inch monitor, and model 3150BA video camera (B&W). Will buy or copy and return. *Heinz TV, P.O. Box 425, San Ysidro, CA 92073.*

Wanted: Schematics and/or manuals for B&K 500 and 650 tube testers, 1075 and 1076 TV analysts, 1240 color-bar generator and 1450 diagnostic oscilloscope. **For Sale:** Tektronix 545 and Hewlett-Packard 170B, 30MHz oscilloscopes, \$100 each. *Jim Corliss, 2446 Vista Drive, Upland, CA 91786; 714-985-9967.*



MAKE ANY TELEVISION OUTPUT STEREO SOUND!!

Increase your profit margins by selling and installing this unique device.



Model SS-2001: The TELEVONIC™ implant unit, installed directly into any Television, creates synthesized stereo output from any channel. When connected with a stereo amplifier or receiver, it will provide a sound system found only in expensive stereo Televisions, at a fraction of the cost.

Works on any TV • Easy to install • 100% Solid State • Microchip technology • Superior Sound quality • 1 year warranty.

**REQUIRES QUALIFIED TECHNICAL INSTALLATION.
DISTRIBUTOR INQUIRIES WELCOMED.**

For Information Contact: Mr. Ernest C. Hassell • Director of Marketing
• Spectrum 2000, Inc. • 4854 Sterling Drive • Boulder, CO 80301
• 1-800-922-6333

TELEVONIC is a trademark of Spectrum 2000, Inc.
Manufactured in the U.S.A. by Spectrum 2000, Inc.

Circle (37) on Reply Card



Advertising rates in the Classified Section are 75 cents per word, each insertion, and must be accompanied by payment to insure publications.

Each initial or abbreviation counts a full word.

Minimum classified charge is \$15.00.

For ads on which replies are sent to us for forwarding (blind ads), there is an additional charge of \$25.00 per insertion to cover department number, processing of replies, and mailing costs.

Classified columns are not open to advertising of any products regularly produced by manufacturers unless used and no longer owned by the manufacturer or distributor.

FOR SALE

AUTOMOBILE RADIO and tape replacement parts. Delco, Chrysler, Philco-Ford, Motorola, Panasonic and many others. Large inventory. *Laran Electronics, Inc., 3768 Boston Road, Bronx, NY 10469. (212) 881-9600. National (800) 223-8314, NY State (800) 446-4430.* 1-85-tfn

BOOTLEGGERS BIBLE for CB Modification \$12.95, CB Radio Repair \$10.95. Linear Amplifier Planbook \$14.95, kits, etc. Catalog \$1.00 refundable—APS, POB 263 Newport, R.I. 02840 401-846-5627. 12-84-tfn

SCRAMBLED TELEVISION, encoding/decoding. New book. Theory/circuits, \$9.95 plus \$1 shipping. Workshop, Box 393ES, Dept. E, Bethpage, NY 11714. 1-85-tfn

SONY-TRINITRON REBUILTS are now available. Call for price & delivery, 1-716-621-5250. 7-86-tfn

TV TROUBLESHOOTING: Over 100 ILLUSTRATED problems-solutions of difficult repairs. Also, 12 steps to easier TV repair, \$12.00. **REMARKABLE DIAGNOSTIC TOOL:** Determine operation of high voltage circuits every time. You will not be mistaken about your conclusions, \$5.00. *Jones, Box 702, Niceville, Fla. 32578.* 5-86-6t

INDIVIDUAL PHOTOFAC FOLDERS (not sets) #1 to #1400, \$3.00 first-class postpaid. *Loeb, 414 Chestnut Lane, East Meadow, NY 11554.* 8-86-6t

TUBES. Unused, in original boxes. Thousands in stock. *SASE to Fala Electronics, P.O. Box 1376-3, Milwaukee, WI 53201.* 8-86-3t

BOXED BRAND NAME TV and Radio Tubes. One Dollar each. Power types Two Dollars. *Carls, 417 South 6th, Sunnyvale, Wa. 98944.* 9-86-2t

TV TOUGH DOGS 200 symptoms and cures. Send \$6.95 to *DAVIS TV, 11772 Old Fashion Way, Garden Grove, CA 92640.* 9-86-3t

VCR REPAIR SOLUTIONS for VHS models. Over 125 symptoms and cures. The hard ones. Send \$9.95 to *Eagle Electronics, 2534 Miracle Lane, Mishawaka, In. 46545.* 9-86-3t

DISCOUNT CATV CONVERTERS/DECODERS and video accessories. Solar cells for remote power and battery charging applications. Send for free information and prices—it could save you big money on your next purchase of these and other CATV items. *Easy View, P.O. Box 221, Arlington Heights, Illinois 60006. (312) 952-8504. Ask for Rudy Valentine.* 8-86-1t

CABLE TV CONVERTERS & EQUIPMENT. Plans and parts. Build or buy. Send S.A.S.E. *C&D Electronics, P.O. Box 1402, Dept. ES&T, Hope, Arkansas 71801.* 1-86-tfn

CB TUNE-UP MANUAL VOLUME II. Specific adjustments and modifications for peaking all popular CB's. Covers over 1300 radios—19.95, Visa, Mastercard to: *Thomas Publishing, 127E Westwood, Paris, IL 61944.* 10-86-1t

3000 COLOR TV REPAIR TIPS, 31 Brands 116 Page Manual. Send \$21.00 to *A. Fernandez, Box 546110, Surfside, Florida 33154.* 10-86-3t

FORSALE: Jerrold gated pulse theory. Twelve information packed pages covering DI & DIC converter operation. Includes introduction to trimode system. \$6.95 plus \$1.50 postage and handling. *Elephant Electronics Inc., Box 41865-E, Phoenix, AZ 85080 (602) 581-1973.* 10-86-tfn

FOR SALE: Descramble the latest video cassette copy protection scheme. Our simple **LINE ZAPPER** circuit takes the jitter out of your picture. Complete plans and theory only \$9.95 plus \$1.50 postage and handling. Printed circuit board or complete kit also available. *Elephant Electronics Inc., Box 41865-E, Phoenix, AZ 85080 (602) 581-1973.* 10-86-tfn

FOR SALE: **MOTOROLA NLN5320B/C** ultra high capacity MX nicad batteries, brand new, guaranteed to test at 100% capacity or better. \$120.00 each. *Ph 619-690-1774, 619-479-2619 or 619-272-0935.* 10-86-1t

ATTENTION SATELLITE DEALERS: See everything with your video cypher 2000E demonstrator on all the transponders. (Secrete modification voids manufacturers warranty.) Send \$24.00 for VC kit. Send \$10.00 for full set of schematics of MA/COM model 2000E receiver. *TV Shop, 127 E. Mission, Fallbrook, CA 92028 (619) 723-1302.* 10-86-1t

HELP WANTED

CAMERA-VIDEO Technicians needed. Top pay and benefits for well trained and experienced technicians who are expert with consumer and/or industrial cameras and VCR's. Training by manufacturers such as Sony, Hitachi, Panasonic, etc., are necessary for job experience. Come to sunny Florida and enjoy your work & leisure time. Write or call **ATLANTIC ELECTRONICS INC.**, 1881 NE 26 St., Ft. Lauderdale, FL 33305. (305) 564-8274 10 AM to 6:30 PM. Ask for Dave or Joe. 8-85-tfn

ELECTRONIC TECHNICIAN/SERVICE SHOP MANAGER needed for small busy repair shop. Send resume to *Whittington's Electronics, 501 Broadway, Truth or Consequences, New Mexico 87901.* 10-86-2t

HELP WANTED (CONT.)

VIDEO/AUDIO technician needed. Top pay and benefits for well trained and experienced technicians who are expert with consumer TV and audio equipment. Training by manufacturers such as: Sony, Hitachi, RCA, Panasonic, etc. are necessary for job experience. Write or call: Atlantic Electronics, Inc., 1881 NE 26th St., Ft. Lauderdale, FL 33305, 305-564-8274 (10 AM 6:30 PM). Ask for Dave or Joe. 06-86-tfn

BUSINESS OPPORTUNITIES

T.V. SALES & SERVICE. Well established business located northern Virginia. Owner retiring and will help with financing. Call 703-972-7027 after 7:00 p.m. EST. 6/85-tfn

3 HOURS FROM SAN FRANCISCO. Electronic repair shop in Pine Forested foothills. Vision problem forces sale. 7 rm residence, lg beautiful gdn all shop equip included, \$155k min 50% dwn req (916)872-1962. 10-86-tfn

RADIO-TV REPAIR SHOP! USA Virgin Islands! Established 15 years—reasonably priced—809-773-7867. 10-86-4t

SERVICES

REPAIR OF ZENITH CIRCUIT BOARD 9-160-all; with dud exchange \$33.00. One year guarantee. Kinirral Electronics, 68-26 64th Place, Glendale, N.Y. 11385. (718) 355-3859. 9-86-3t

WANTED TO BUY

WANTED: Whip Antenna's for portable telephones, also a supply of telephone parts, tone pads, K-sets, switches, etc., etc. Electronic Doctor, 1869 E. Main St., Peekskill, NY 10566. 10-86-1t

MISCELLANEOUS FOR SALE

ATTENTION TECHNICIANS. Build your own in circuit component tester for under \$10.00. Free information. Box 073, Elkhorn, Wis. 53121. 10-86-1t

**NATIONAL REBUILT HEADQ. FOR —
SONY REBUILT
PICTURE TUBES**
2 YR. WARR. — FREE U.P.S.-DEL.
716-621-5250

Circle (32) on Reply Card

Tech's Guide To Pricing
updated new 5th edition...a framework for setting rates that apply to Hi-Tech products...a formula that guarantees SUCCESS!
Call Toll Free for details **1-800-228-4338** 8/5 CST

Circle (33) on Reply Card

ELECTRONIC SERVICING & TECHNOLOGY Vol 6, No. 10 (USPS 462-050) is published monthly by Intertec Publishing Corp., 9221 Quivira Road, P.O. Box 12901, Overland Park, KS 66212. Second Class Postage paid at Shawnee Mission, KS, and additional mailing offices. POSTMASTER: Send address changes to ELECTRONIC SERVICING & TECHNOLOGY, P.O. Box 12952, Overland Park, KS 66212-9981.

Circle (36) on Reply Card

Advertisers' Index

	Page Number	Reader Service Number	Advertiser Hotline
A.F. Publishing	66	36	
Automated Production Equipment Corp.	56	20	516/654-1197
Ava Instrumentation Inc.	57	22	408/336-2281
Beckman Industrial Corp.	9	6	714/671-4800
Caig Laboratories, Inc.	59	24	619/743-7143
Chemtronics, Inc.	29	11	800/645-5244
Cleveland Institute of Electronics	7	5	800/321-2155
Dandy Mfg. Co.	66	34	800/331-9658
Diehl Enterprises	21,23,25,27	10	806/359-0329
Digitron Electronic	56	21	800/526-4928
Electronic Parts Supply	60	30	800/227-0104
Fluke, John Mfg. Co., Inc.	5	4	800/227-3800
Fordham Radio Supply Co.	19	9	800/645-9518
Jenks W.S. & Sons	60	26	800/638-6405
Leader Instrument Corp.	IFC	1,2	514/337-9500
MCM Electronics	63	29	800/543-4330
NARDA	61	23	312/953-8950
Nippon American Inc.	61	28	800/327-7522
NRI Schools — Electronics Division	17		202/244-1600
Optima Electronics	3	38	305/652-3971
Precision Picture Tubes	66	32	716/621-5250
Projector Recorder Belt Corp.	60	27	800/558-9572
PTS Corp.	53	17	812/824-9331
RCA Distributor and Special Products	11	7	
Sams, Howard W. & Co., Inc.	51	16	800/428-SAMS
Sencore, Inc.	41,43	12,13	800/843-3338
Sencore, Inc.	45,47	14,15	800/843-3338
Spectrum 2000 Inc.	65	37	800/922-6333
Sperry AW Instruments Inc.	13	8	800/645-5398
Sperry Tech, Inc.	66	33	800/228-4338
Technipower/A Penril Co.	64	39	
Tektronix, Inc.	IBC	3	800/433-2323
Tentel	64	31	800/538-6894
U.S. Instrument Rentals	55	19	800/824-2873
Unity Electronics	66	35	201/351-4200
Vu-Data Corp.	54	18	619/452-7670
Wahl Clipper Corp.	59	25	815/625-6525
Zenith	BC		

DANDY-DAPTER™

PATENTED CRT ADAPTER—Don't buy another socket for your CRT Tester! This is the **Only** way you can win the Socket War! Guaranteed to fit your tester & allow you to test/clean/restore ANY Color, B/W, Projection, Scope or Camera CRTs. Visa/M-Card, Checks, CODs. New Low Price \$59.95 (We pay UPS) 1(800) 331-9658. DANDY ELECTRONICS, 2323 GIBSON, MUSKOGEE, OK 74403



Circle (34) on Reply Card

NEW 20-PAGE CATALOG FREE **7 MILLION TUBES**
Includes all current, obsolete, antique, hard-to-find receiving, transmitting, industrial, radio/TV types. **LOWEST PRICES.** Major brands in stock.
Unity Electronics Dept. E
P.O. Box 213, Elizabeth, N.J. 07206



Circle (35) on Reply Card

ELECTRONIC

Servicing & Technology

KANSAS CITY, MISSOURI
Greg Garrison, Sales Manager
P.O. Box 12901
Overland Park, KS 66212
Phone: 1-913-888-4664

NORWOOD, AUSTRALIA
Hastwell, Williamson, Rouse PTY. LTD.
P.O. Box 419
Phone: 332-3322
Telex AA 87113

LONDON, ENGLAND
Nicholas McGeachin
Suite 460, Southbank House
Black Prince Road, London SE1 7SJ
Telex: 295555 LSPG
Telephones: Central Line 01 582-7522
Direct Line 01 587-1578

TOKYO, JAPAN
EMS, Inc.
Sagami Bldg., 4-2-21,
Shinjuku, Shinjuku-ku,
Tokyo 160, Japan
(03) 350-5666
Telex: 2322520 EMSINCJ
Cable: EMSINCPERIOD

New GPS Series: Tek sets the pace with SmartCursors™ and push-button ease.

Work faster, smarter, with two new general purpose scopes from Tektronix. The four-channel, 100 MHz 2246 and 2245 set the new, fast pace for measurements at the bench or in the field. They're easy to use and afford, by design.

On top: the 2246 with exclusive integrated push-button measurements. Measurements are accessed through easy, pop-up menus and implemented at the touch of a button. Measure peak volts, peak-to-peak, \pm peak, dc volts and gated volts with new hands-off convenience and on-screen readout of values.

SmartCursors™ track voltmeter measurements in the 2246 and visually indicate where ground and trigger levels are located. Or use cursors in the manual mode for immediate, effortless measurement of waveform parameters.

Both scopes build on performance you haven't seen at the bandwidth or prices. Lab grade features include sweep speeds to 2 ns/div. Vertical sensitivity of 2 mV/div at full bandwidth for low-level signal capture. Plus trigger

Features	2246	2245
Bandwidth	100 MHz	100 MHz
No. of Channels	4	4
Scale Factor Readout	Yes	Yes
SmartCursors™	Yes	No
Volts Cursors	Yes	No
Time Cursors	Yes	No
Voltmeter	Yes	No
Vertical Sensitivity	2 mV/div	2 mV/div
Max. Sweep Speed	2 ns/div	2 ns/div
Vert/Hor Accuracy	2%	2%
Trigger Modes	Auto Level, Auto, Norm, TV Field, TV Line, Single Sweep	
Trigger Level Readout	Yes	No
Weight	6.1 kg	6.1 kg
Warranty	3-year on parts and labor including CRT	
Price	\$2400	\$1875

sensitivity to 0.25 div at 50 MHz, to 0.5 div at 150 MHz.

Accuracy is excellent: 2% at vertical, 2% at horizontal. And four-channel capability includes two channels optimized for logic signals.

Best of all, high performance comes with unmatched convenience. You can see it and feel it — in the

responsive controls and simple front-panel design, in extensive on-screen scale factor readouts, and in simplified trigger operation that includes Tek's Auto Level mode for automatic triggering on any signal. Start to finish, the GPS Series saves steps and simplifies tasks.

Get out in front! Call toll-free today to order, to get more details or a videotape demonstration.

1-800-433-2323

In Oregon, call collect 1-627-9000

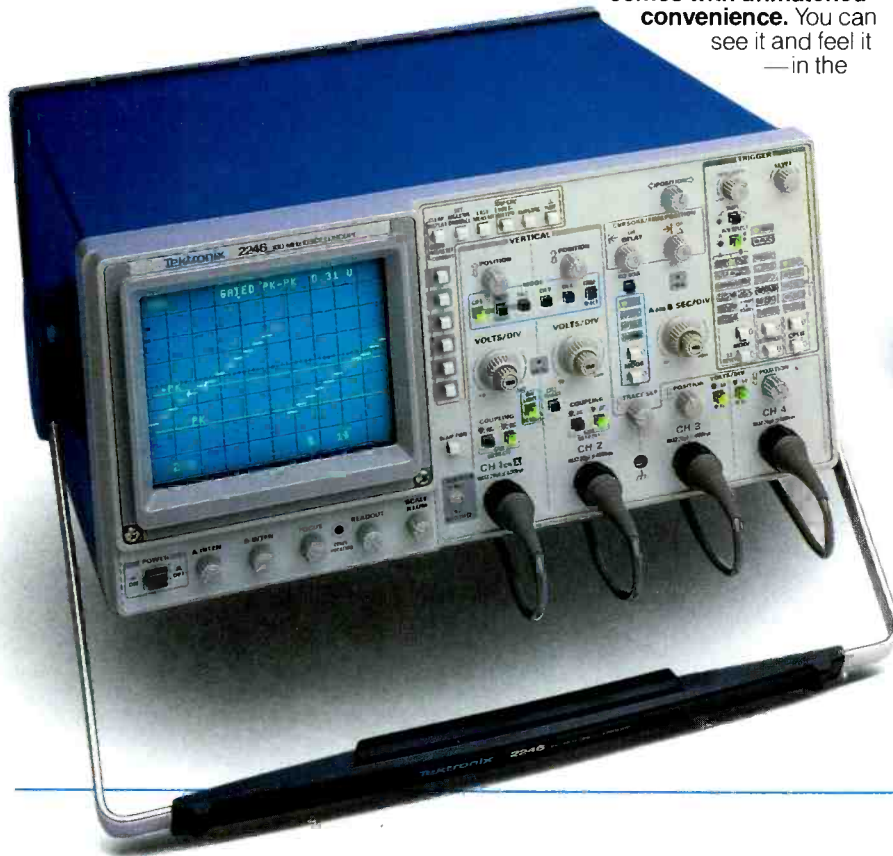

Featuring four channels, flexible triggering, extensive CRT readouts and push-button ease of use, the new Tek 2246 (left) and 2245 (above) bring high-quality, low-cost analysis to diverse applications in digital design, field service and manufacturing.

Tektronix®
COMMITTED TO EXCELLENCE

Circle (3) on Reply Card

You bet you can make it big in the consumer electronics business by selling Zenith Video/Audio Accessories to the same people whose electronic products you now service.

Like all Zenith products, Zenith Audio/Video Accessories are made to the same uncompromising quality and performance standards that have earned Zenith a reputation unsurpassed in consumer electronics.

And it goes without saying that the better known and the more respected a product's name the easier, faster, and the more profitably you can sell it across the counter ...or while you're out of the shop on a service call.

To learn how it's done, how other service techs just like you are cashing in on the selling power of the Zenith name, call your Zenith distributor's Accessory Sales Manager now.

Everything you need is there at your Zenith distributor's place — the help and encouragement of an

experienced Zenith Accessory Sales Manager...the selling power of the Zenith name on video and audio accessories...and the overall support of your Zenith distributor's dedicated personnel.

With easy access to this wealth of know-how, you should have no trouble turning some 6, 7 or 8 feet of your floor space into a very respectable profit center. With Zenith Electronic Accessories, of course.

Call your Zenith distributor's Accessory Sales Manager now or write direct for the name of the Zenith distributor serving your area.

Call or write now, today!



The quality goes in before the name goes on.®

Zenith Service, Parts & Accessories • Department 30 • 11000 Seymour Avenue, Franklin Park, Illinois 60131 • A Division of Zenith Electronics Corporation



DEALER  **INQUIRIES INVITED**

